

# MANN+HUMMEL EDM Filter



MANN+HUMMEL  
**MANN  
FILTER**

# **MANN+HUMMEL EDM Filter / EDM Filters**

## **Händler Katalog / Distributors catalogue**

### **Inhaltsverzeichnis / Table of contents**

- 1 Wir über uns / About us**
- 2 Technik & Umwelt / Technology & Environment**
- 3 Piktogrammübersicht / Pictogram overview**
- 4 +GF + Agie Charmilles**
- 5 Mitsubishi Electric**
- 6 Makino**
- 7 Fanuc**
- 8 Sodick**
- 9 OPS-Ingersoll**
- 10 Sonstige EDM Filter / Miscellaneous EDM Filters**
- 11 Zubehör / Accessories**





**Wir über uns / About us**



## **MANN+HUMMEL EDM Filter**







## Unsere Stärken – Ihre Vorteile.

Mit mehr als 10.000 Mitarbeitern an über 41 Standorten zählt die MANN+HUMMEL Gruppe zu den Marktführern in der Filtertechnik.

Mit modernsten Entwicklungs- und Produktionstechnologien setzt MANN+HUMMEL zukunftsweisende Trends bei Filtrationsprodukten für Automobil- und Industrieanwendungen.

Unser Geschäftsbereich Industriefilter ist - neben vielen weiteren Anwendungsbereichen - spezialisiert auf Entwicklung, Produktion und Vertrieb von hocheffizienten Filterelementen für die Funkenerosion.

Die weitreichenden Erfahrungen aus Millionen von Filteranwendungen in dieser Branche sind die Basis für ein einzigartiges EDM-Filterprogramm.



### Eine „runde“ Sache.

Am Industriefilterstandort in Speyer sind Entwicklung und Vertrieb für unsere EDM-Filter angesiedelt. Von hier aus wird die Belieferung unserer OEM-Kunden und Fachhändler zentral gesteuert. Desweiteren betreut das EDM-Team in Speyer unsere weltweiten Vertretungen und Handelspartner.



### Eine „große“ Sache.

In unserem Produktionswerk in Marklkofen, Bayern entstehen im Schnitt täglich über 500.000 Filter für das gesamte Filterprogramm. Das hohe Qualitätsniveau für die Automobilfilterproduktion bietet mit der ISO/TS 16949 Zertifizierung eine hochwertige Fertigungsbasis für unsere EDM-Filter.

# Kunststofffilterprogramm ...



## Welchen Filter brauchen Sie?

In der Funkenerosion werden die Grenzen des technisch Machbaren täglich neu definiert.

Die erreichbare Qualität des Werkstücks ist dabei eng verknüpft mit den eingesetzten Fertigungsmitteln und Prozesstechniken. Nur mit genau abgestimmten Parametern und den dazu passenden Verbrauchsmaterialien lassen sich optimale Erodierergebnisse erzielen.

## Gehen Sie auf Nummer Sicher!

Als langjähriger Entwicklungspartner und Serienlieferant namhafter Erodiermaschinenhersteller haben wir ein Filterprogramm entwickelt, das exakt auf die Bedürfnisse des Erodierprozesses zugeschnitten ist.

Damit unsere Filter in der Erodieranwendung Höchstleistungen erbringen können, werden ausschließlich von MANN+HUMMEL entwickelte und getestete Filtermedien verwendet, die maximale Schmutzaufnahmekapazitäten und sehr lange Standzeiten bieten.





## ... und Metallfilterprogramm



### Welchen Filter bevorzugen Sie?

Genauso vielfältig wie die Erodieranwendungen sind die Präferenzen unserer Anwender. Ob Metallfilter oder Kunststofffilter, ob Standardfilterfläche oder Doppelbalgtechnologie, ob 1-2  $\mu\text{m}$ , 3-5  $\mu\text{m}$ , 10  $\mu\text{m}$  oder 25  $\mu\text{m}$  – wir haben genau den Filter, den Sie bevorzugen.

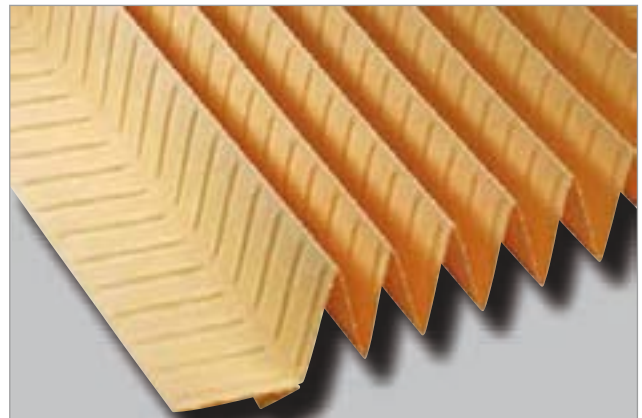

### Setzen Sie auf Qualität!

Egal ob Sie Werkzeugstahl oder Aluminium bearbeiten, ob Sie Senk- oder Drahterodieren - verlassen Sie sich auf unser Know-how und die Verwendung hochwertiger Komponenten.

#### Wichtige Qualitätsmerkmale unserer Filter sind:

- Zuverlässige Imprägnierung des Filtermediums
- Korrosionsbeständigkeit der Filtermaterialien
- 3 bar Druckbeständigkeit des Filtergehäuses
- Chemisch neutrales Verhalten
- Gutes manuelles Handling

**Ein weiteres Plus für umweltbewusste Anwender:** MANN+HUMMEL Kunststofffilter schonen nicht nur die Umwelt, sondern auch den Geldbeutel.

Gute Filtration	Schlechte Filtration
+ Optimaler Prozess + Zeitoptimierung + Weniger Wartung	- Qualitätseinbußen - Zeitverlust - Höherer Verschleiß
$\Sigma$ = Geldeinsparung	$\Sigma$ = Geldverschwendung

## Let's talk about money!

Jeder Autobesitzer weiß, dass man nur mit einem gut gewarteten Fahrzeug sicher und zuverlässig an sein Ziel kommt. Stimmt die Ausrüstung nicht oder versagt die Technik, verlängert sich die Fahrzeit und im schlimmeren Fall kommt man gar nicht an.

Ähnlich verhält es sich auch mit Erodiermaschinen. Nur eine optimal ausgerüstete Erodiermaschine bringt Höchstleistungen und damit wertvolle Zeiterparnis sowie eine hohe Verfügbarkeit.

**Und wer kann es sich leisten, Arbeitszeit und Geld zu verschenken?**



Ein zusätzlicher Effekt: Neben der Arbeitszeiterparnis sinken durch eine effiziente Filtration auch die Kosten für Instandhaltung und Verschleißteile. Weniger Partikel im Dielektrikum bedeuten weniger Verschleiß der mechanisch beanspruchten Teile wie Drahtführungen sowie längere Lebensdauer von Magnetventilen und damit eine erhöhte Verfügbarkeit und Werterhaltung Ihrer Erodiermaschine.

Sparen Sie Geld und Zeit, die Sie wieder gut in Ihre Kunden investieren können. Das bringt Ihnen echte Wettbewerbsvorteile!

**Diese Nutzevorteile können Sie durch eine hocheffiziente Filtration mit MANN-FILTER erreichen:**

- Höhere Schnittgeschwindigkeiten
- Schneller direkt auf Fertigmaß erodieren
- Reduzierung der Sekundärerrosion
- Hochqualitative Oberflächengüten
- Gute, reproduzierbare Werkstückgenauigkeiten
- Stabile Leitwerte des Dielektrikums
- Optimierung des Ionisierharzverbrauchs
- Reduzierter Maschinenverschleiß
- Senkung des Wartungsaufwands

**Nicht umsonst verwenden viele namhafte Erodiermaschinenhersteller unsere MANN-FILTER als Erstausrüstung!**





- MANN+HUMMEL Standorte
- Gemeinschaftsunternehmen

## MANN+HUMMEL Standorte in Ihrer Nähe!

Unsere Vertriebsrepräsentanten in allen wichtigen Ländern Europas, Amerikas, Südamerikas und Asiens bieten Ihnen vorort umfassende Unterstützung. Wo auch immer Ihr Standort ist, wenn Sie Fragen haben oder eine Beratung wünschen, rufen Sie uns an oder schicken Sie uns eine E-Mail!

**England** (West Malling, Kent)  
Tel.: +44 1732 523533  
E-Mail: uk.info@mann-hummel.com

**Frankreich** (Sartrouville)  
Tel.: +33 2 43 49 73 74  
E-Mail: marketing.si@mann-hummel.com

**Italien** (Sondrio, SO)  
Tel.: +39 0342 2112 70  
E-Mail: it.info@mann-hummel.com

**Russland** (Moskau)  
Tel.: +7 495 742 7976  
E-Mail: info.ru@mann-hummel.com

**Spanien / Portugal** (Zaragoza)  
Tel.: +34 (976) 287 300  
E-Mail: mhes@mann-hummel.com

**Tschechische Republik** (Okříšky)  
Tel.: +420 568 898 111  
E-Mail: cz.info@mann-hummel.com

**Argentinien** (Buenos Aires)  
Tel.: +54 11 4208 1200  
E-Mail: info@mann-hummel.com.ar

**Brasilien** (Indaiatuba-SP)  
Tel.: +55 19 3894 94 00  
E-Mail: marketec@mann-hummel.com.br

**Mexiko** (Santiago de Querétaro)  
Tel.: +52 442 103 1100  
E-Mail: infomx@mann-hummel.com

**USA / Kanada** (Portage MI)  
Tel.: +1 (269) 329-7200  
E-Mail: info-us@mann-hummel.com

**Australien** (Newington, NSW)  
Tel.: +61 2 9647 1700  
E-Mail: info@mann-hummel.com.au

**China** (Shanghai)  
Tel.: +86 21 6104 3222  
E-Mail: infomhcn@mann-hummel.com

**Indien** (Bangalore)  
Tel.: +91 80 4020 7100  
E-Mail: office.india@mann-hummel.com

**Japan** (Yokohama)  
Tel.: +81 (45) 470-4588  
E-Mail: info.jp@mann-hummel.com

**Korea** (Seoul)  
Tel.: +82 (2) 2059 5781  
E-Mail: info.kr@mann-hummel.com

**Singapur**  
Tel.: +65 6586 8181  
E-Mail: mhsg@mann-hummel.com



**MANN+HUMMEL GMBH**, Geschäftsbereich Industriefilter  
67346 Speyer, Germany, Telefon +49 (62 32) 53-80, Fax +49 (62 32) 53-88 99  
E-Mail: edm.info@mann-hummel.com, Internet: www.mann-hummel.com



## **MANN+HUMMEL EDM Filters**







## Our strengths – Your advantages.

With over 10,000 employees at over 41 locations, the MANN+HUMMEL Group is a market leader in the area of filtration technology.

With the most modern of development and production technologies, MANN+HUMMEL is a trend-setter for filtration products used in automotive and industrial applications.

Our Industrial Filters Business Unit - in addition to many other applications - specialises in development, production and sales of highly efficient filter elements for electro erosion.

Extensive experience from millions of filter applications in this industry is the basis for a unique EDM filter program.



### Something "round".

Development and sales for our EDM filters are located at the industry filter location in Speyer. From here, the supply to our OEM customers and specialty retailers is managed. The EDM team in Speyer supports our representatives and trading partners worldwide.



### Something "large".

At our production plant in Marklkofen in Bavaria, over 500,000 filters on average are produced daily for the entire filter program. Based on ISO/TS 16949 standard our high quality automotive filter production provides a premium class production platform for our EDM filters.

# Plastic filter program ...



## Which filter do you need?

In the EDM business, the borders of technical feasibility are being defined on a daily basis. The achievable quality of the workpiece is, in the process, tightly linked with the tooling and process technologies used. Only with accurately coordinated parameters and the appropriate consumables are optimal erosion results produced.

## Play it safe!

As a long-standing development partner and series supplier to well-known erosion machine manufacturers, we have developed a filter program which is tailored specifically to the needs of the erosion process.

So that our filters perform optimally in the task of erosion, filter medias exclusively developed and tested by MANN+HUMMEL are used, offering maximum dirt holding capacity and providing very long service life.





## ... and metal filter program



### Which filter do you prefer?

Just as varied as the erosion applications are the preferences of our customers. Whether metal filter or plastic filter, whether standard filter surface or double bellows technology, whether 1-2  $\mu\text{m}$ , 3-5  $\mu\text{m}$ , 10  $\mu\text{m}$  or 25  $\mu\text{m}$  - we have exactly the right filter for you.

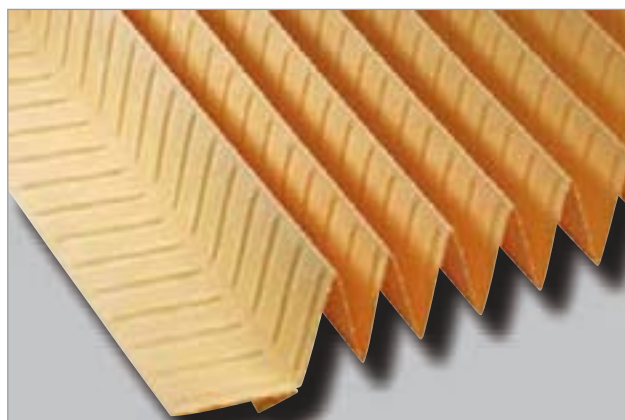

### Decide on quality!

Regardless of whether you work on tool steel or aluminium, with sink or wire erosion - you can rely on our expertise and our use of top quality components.

#### Our filters feature the following important quality characteristics:

- Reliable impregnation of the filter medium
- Corrosion resistance of the filter materials
- 3-bar pressure resistance of the filter housing
- Chemically neutral properties
- Easy manual handling

**A further plus for environmentally aware users:** MANN+HUMMEL plastic filters are an economical and convenient solution to environmental issues.

Good filtration	Bad filtration
+ Optimal process + Time optimisation + Reduced maintenance	- Reduced quality - Loss of time - Higher wear level
$\Sigma$ = Money savings	$\Sigma$ = Money wastings

## Let's talk about money!

Every car owner knows that you will only reach your destination safely and reliably with a well maintained vehicle. If the machinery is not right or the technology fails, the driving time is extended and, in a worst case scenario, you won't reach your destination at all.

It is a similar situation with erosion machines. Only an optimally equipped erosion machine delivers top performance, as well as high service quality, thus, saving valuable time.

**And who can afford to waste time and money?**

An added benefit: In addition to time savings at work, the costs also decrease for maintenance and wear parts due to efficient filtration. Fewer particles in the dielectric mean less wear on mechanically-stressed parts such as wire guides. And prolonging the service life of solenoid valves reduces service costs and conserves the value of your erosion machine.

Save time and money which you can better invest in your customers. Bringing you real competitive advantages!



**Benefit from the following advantages by means of highly efficient filtration with MANN-FILTER:**

- Higher cutting speeds
- Erode directly to final dimension
- Reduction of secondary erosion operation
- Higher quality surface finish
- Improved workpiece tolerance
- Stable conductivity of the dielectric
- Optimisation of the ionising resin consumption
- Reduced machine wear
- Reduction of maintenance costs

**It's no wonder why many well-known erosion machine manufacturers use MANN-FILTER as original equipment!**





- MANN+HUMMEL Companies
- Joint ventures

## MANN+HUMMEL locations near you!

Our sales representatives in all the major countries of Europe, America, South America and Asia will provide you with comprehensive support on site. Wherever your location, if you need further information or if you have any questions, simply call us or send us an e-mail!

**England** (West Malling, Kent)  
Tel.: +44 1732 523533  
E-mail: uk.info@mann-hummel.com

**France** (Sartrouville)  
Tel.: +33 2 43 49 73 74  
E-mail: marketing.si@mann-hummel.com

**Italy** (Sondrio, SO)  
Tel.: +39 0342 2112 70  
E-mail: it.info@mann-hummel.com

**Russia** (Moscow)  
Tel.: +7 495 742 7976  
E-mail: info.ru@mann-hummel.com

**Spain / Portugal** (Zaragoza)  
Tel.: +34 (976) 287 300  
E-mail: mhes@mann-hummel.com

**Czech Republic** (Okříšky)  
Tel.: +420 568 898 111  
E-mail: cz.info@mann-hummel.com

**Argentina** (Buenos Aires)  
Tel.: +54 11 4208 1200  
E-mail: info@mann-hummel.com.ar

**Brazil** (Indaiatuba-SP)  
Tel.: +55 19 3894 94 00  
E-mail: marketec@mann-hummel.com.br

**Mexico** (Santiago de Querétaro)  
Tel.: +52 442 103 1100  
E-mail: infomx@mann-hummel.com

**USA / Canada** (Portage MI)  
Tel.: +1 (269) 329-7200  
E-mail: info-us@mann-hummel.com

**Australia** (Newington, NSW)  
Tel.: +61 2 9647 1700  
E-mail: info@mann-hummel.com.au

**China** (Shanghai)  
Tel.: +86 21 6104 3222  
E-mail: infomhcn@mann-hummel.com

**India** (Bangalore)  
Tel.: +91 80 4020 7100  
E-mail: office.india@mann-hummel.com

**Japan** (Yokohama)  
Tel.: +81 (45) 470-4588  
E-mail: info.jp@mann-hummel.com

**Korea** (Seoul)  
Tel.: +82 (2) 2059 5781  
E-mail: info.kr@mann-hummel.com

**Singapore**  
Tel.: +65 6586 8181  
E-mail: mhsg@mann-hummel.com

**MANN+HUMMEL GMBH**, Industrial Filters Business Unit  
67346 Speyer, Germany, Telephone +49 (62 32) 53-80, Fax +49 (62 32) 53-88 99  
E-mail: edm.info@mann-hummel.com, Internet: www.mann-hummel.com



# **Technik & Umwelt / Technology & Environment**



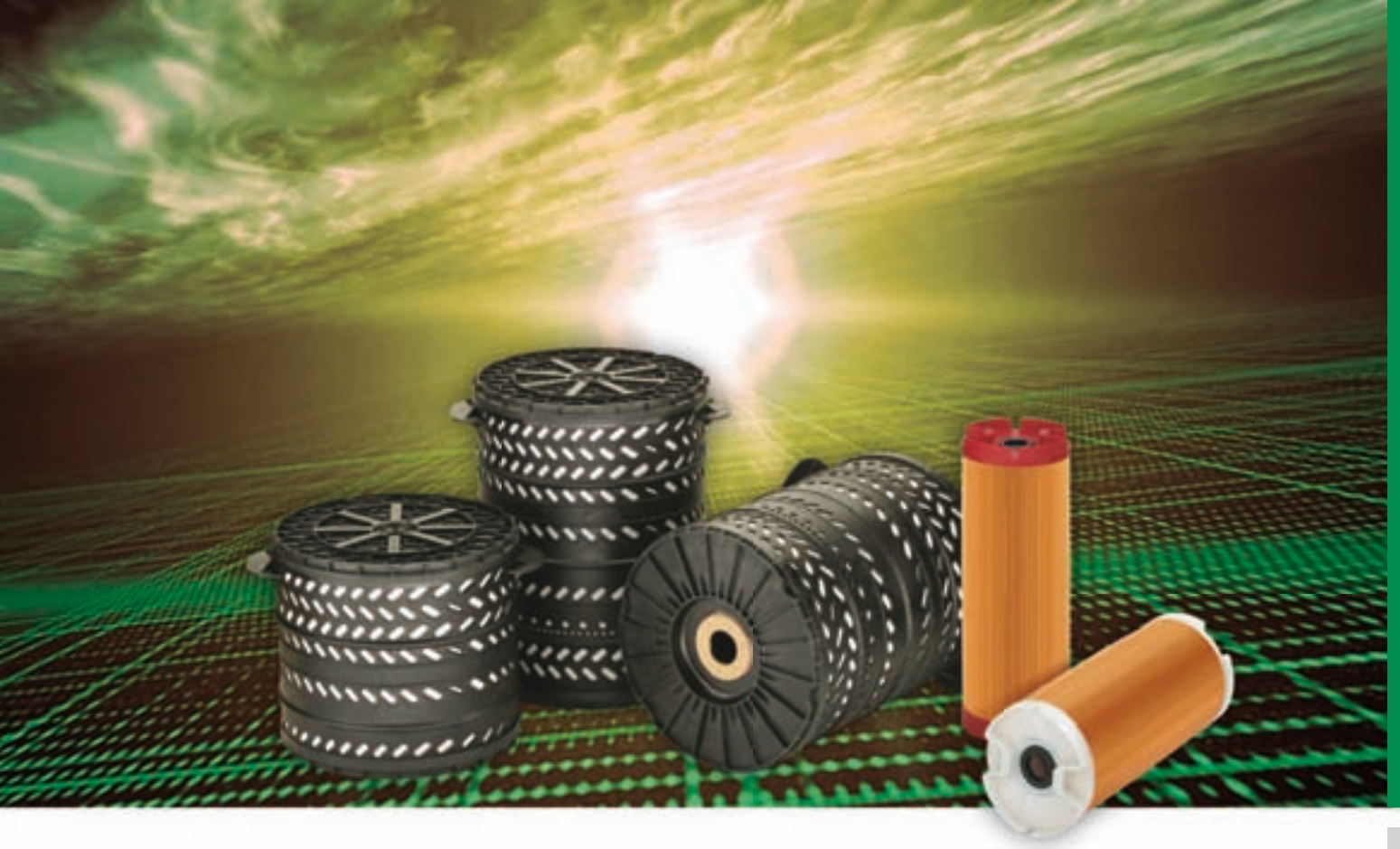

## **MANN+HUMMEL EDM Filter**

### **Technisches Know-how für die Erodierertechnik**





## Im globalen Wettbewerb bestehen

Extremer Termin- und Kostendruck, hohe Qualitätsanforderungen und komplexe Bauteile - die Fertigung von Werkzeugen und Formen stellt heute enorme Anforderungen an die Produzenten. Um im globalen Wettbewerb bestehen und Führungspositionen ausbauen zu können, bedarf es Produkten, die den komplexen Anforderungen der Funkenerosion gerecht werden. Der zunehmende Innovationsdruck bei gleichzeitig steigendem Anspruch an Zuverlässigkeit und Verfügbarkeit verlangt in der EDM-Produktion nach ganzheitlichen Fertigungslösungen.

MANN+HUMMEL entwickelt und fertigt seit vielen Jahren hocheffiziente Filterelemente für die Funkenerosion. Seite an Seite mit den großen Erodiermaschinenherstellern haben wir bis heute unzählige Filterelemente für die unterschiedlichen Anwendungen maßgeschneidert.

Eine wichtige Basis hierfür sind unsere Entwicklungs- und Versuchslabore, die mit speziellen Prüf- und Versuchseinrichtungen ausgerüstet sind. Unsere umfassenden Funktionstests unter realen Bedingungen bis hin zu Validierungen von OE-Filtern bieten unseren Kunden jederzeit erstklassige Erodierfilter.



Validierung im MANN+HUMMEL Versuchslabor





## Kompetenz in Entwicklung und Fertigung

MANN+HUMMEL verzichtet als einziger EDM-Filterhersteller weltweit bei den weitverbreiteten Kunststoffelementen mit  $\varnothing$  150 mm vollständig auf die Verwendung von Klebstoff und Metall. Mittels modernster Spiegelschweißtechnik wird der Filterbalg direkt mit der Kunststoffendscheibe verschweißt und bildet eine dichte, dauerhafteste Verbindung. Diese Bauform verhindert zuverlässig unerwünschte chemische Einflüsse auf das Dielektrikum und sorgt somit für stabile EDM-Prozesse.

Bei den Großfiltern ist es dank modernster Entwicklungsmethoden gelungen, den Anschluß- und Einströmbereich in den Endscheiben zu optimieren. Durch diese Auslegung können die Kunststoffteile spannungs- und verzugsarm mit dem Gas-Injektions-Verfahren hergestellt werden.

Ein weiteres Plus für die EDM-Filtration: Die Filter werden gleichmäßig angeströmt, die Filterbälge kontinuierlich beladen und die Standzeiten optimiert.

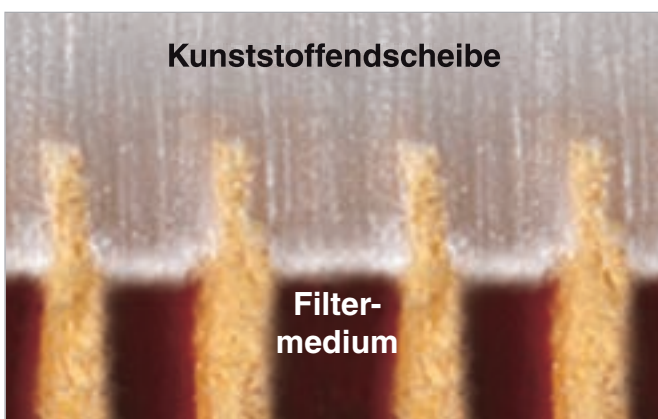

Klebstofffreie Verbindungstechnik mittels Spiegelschweißen

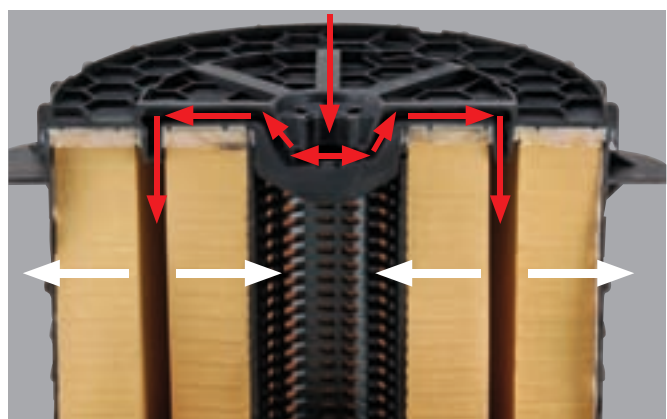

Strömungsoptimierte Endscheiben

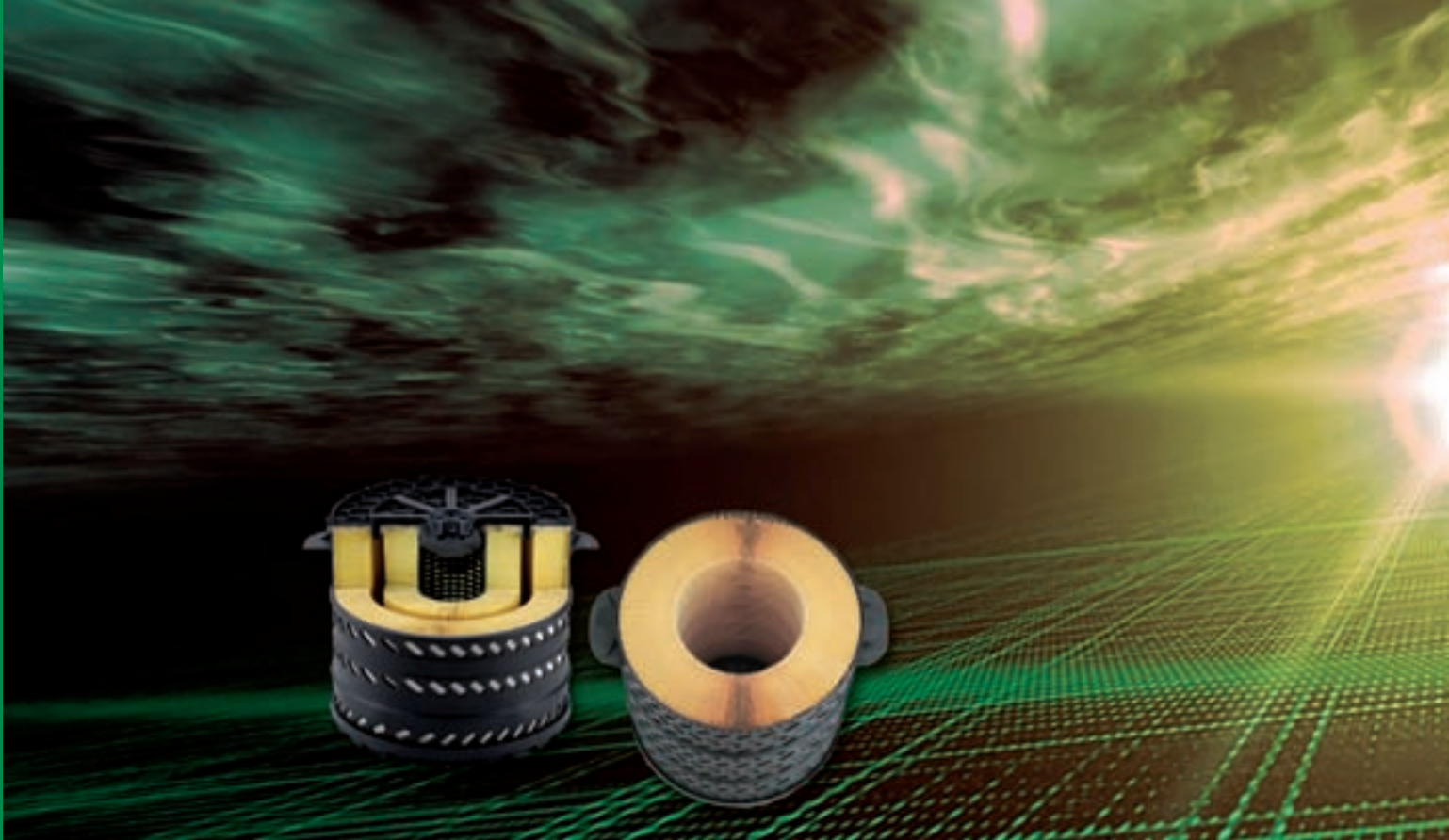

## Kompetenz in Medien- und Filtertechnik

Durch modernste Testverfahren in der Medienentwicklung steht eine optimale Auswahl an Filtermedien zur Verfügung. Filterfeinheiten von 1-2, 3-5, 10 und 25  $\mu\text{m}$  sowie verschiedene Zellulose- und Mischfasermedien bieten für jede Materialbearbeitung die optimale Lösung. Dazu kommt noch die aufwendige Imprägnierung und Aushärtung der Filtermedien. Damit kann eine hohe Druck- und Wasserbeständigkeit des Filterpapiers erreicht werden.

### Für mehr Leistung

Für noch mehr Filterfläche und Performance werden verschiedene Filterbalgtechnologien angeboten. Bei der Makrofaltentechnologie kommen vergrößerte Sternfalten von 75 mm Höhe zum Einsatz. Die Doppelbalgtechnologie erreicht mit 2 x 48 mm Faltenhöhe die maximale Ausnutzung des Einbauraums und steigert die Schmutzaufnahmefähigkeit. Gegenüber Standardfiltern bieten diese beiden Balgtechnologien ein zusätzliches Plus an Filtereffizienz und Standzeit.

REM-Aufnahmen der Filtermedien

**Mischfaser**

**Zellulose**

Joachim Stinzendörfer,  
Medienentwicklung  
MANN+HUMMEL Industriefilter





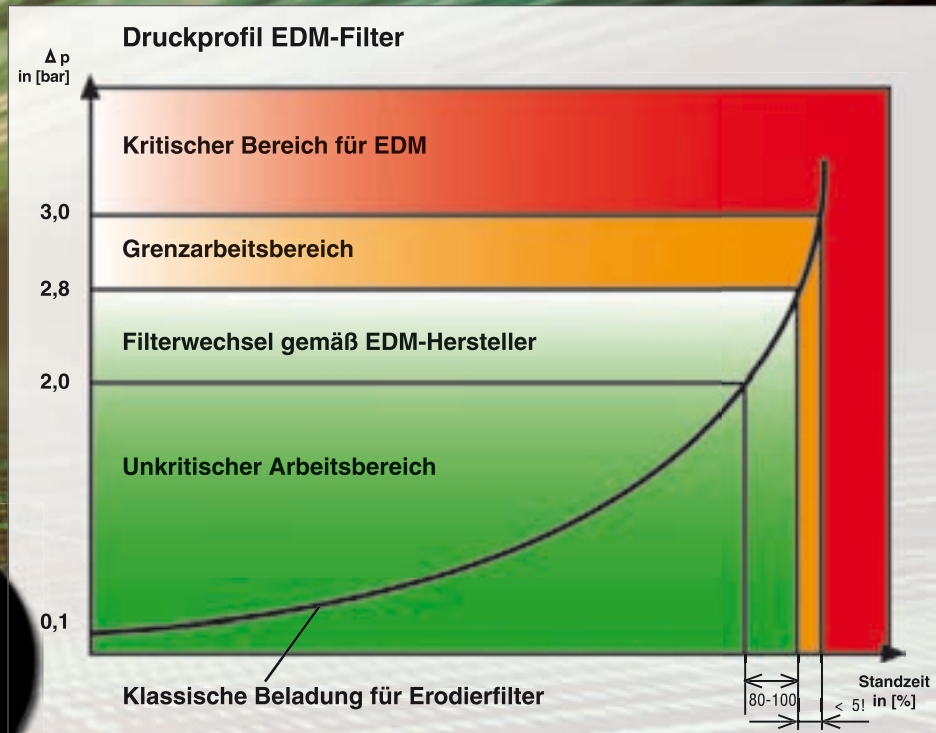

## Sicherheit durch Druckbeständigkeit

Was für die Automobilhersteller der Bremstest ist, ist für die Filterhersteller der Druckbeständigkeitstest. Und genau wie die Automobilindustrie an der Sicherheit ihrer Kunden interessiert ist, möchten wir unseren Kunden eine dauerhaft sichere Erodierfiltration bieten. MANN+HUMMEL EDM-Filter sind für einen kurzzeitigen Differenzdruck von 3 bar ausgelegt.

### Was passiert bei steigendem Druck im Filter?

Mit zunehmender Partikelbeladung steigt der Differenzdruck im EDM-Filter überproportional an (siehe Schaubild). Dadurch erhöht sich der Innendruck im Filter gegen Ende des Lebenszyklus erheblich schneller als am Anfang, d.h. der Grenzarbeitsbereich ist zeitlich nur sehr kurz nutzbar. Eine Überschreitung dieses Bereiches ist eine ernste Gefahr für die Erodiermaschine.

### Auf der sicheren Seite

Um das Filtersystem vor dauerhaft hohen Drücken zu schützen und die Prozesssicherheit zu gewährleisten, liegen die maschinenseitig zulässigen Betriebsdrücke in Bereichen von 2 bis 2,8 bar. Auch wenn MANN+HUMMEL EDM-Filter kurzzeitige Reserven bis 3 bar bieten, sind für den dauerhaft sicheren EDM-Betrieb in erster Linie immer die Angaben der Maschinenhersteller relevant.



3 bar = 0,3 MPa = 43,5 psi

max. 3 bar

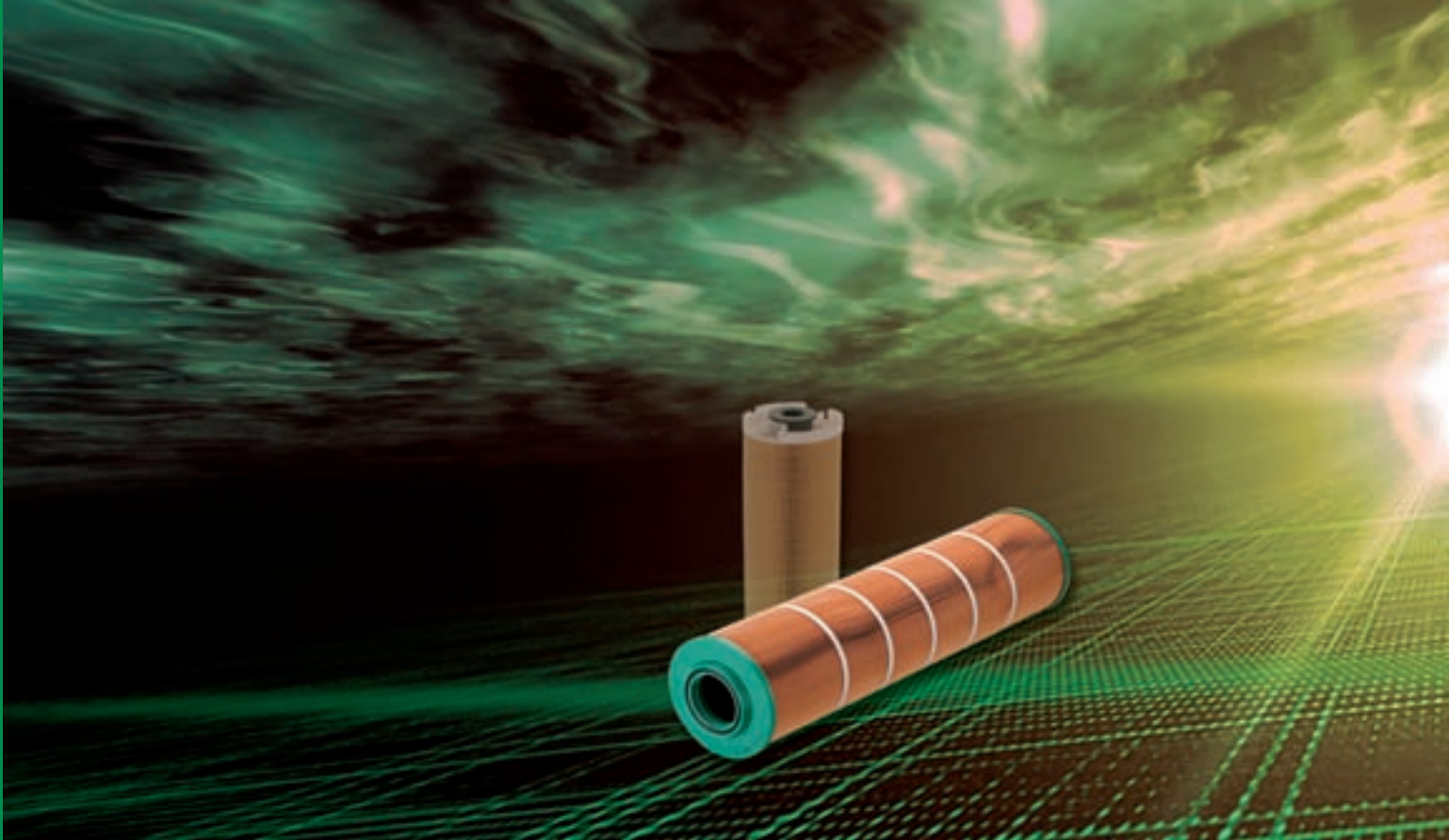

## Plug & Play - Mehr als nur Filter

Mit dem Filterprogramm von MANN+HUMMEL entscheiden Sie sich für ein Höchstmaß an Präzision und Flexibilität. Das durchdachte Programm wird ergänzt durch das umfangreiche Zubehörsortiment.

Bei der Zusammenstellung greifen wir auf praxiserprobte Produkte zurück, die speziell für eine einfache Handhabung und maximalen Anwendungskomfort ausgewählt werden.

Für die unterschiedlichsten Prozessanforderungen in der Erodierfiltration bietet Ihnen MANN+HUMMEL somit genau die Flexibilität, die Sie brauchen.

**Und das alles aus einer Hand.**







## Spitzentechnik für Spitzenresultate

Mit unserer Kompetenz im Bereich Erodierfiltration profitieren Sie von einem Technologievorsprung. Nutzen Sie hocheffiziente MANN+HUMMEL EDM Filterelemente, die genau auf die Marktanforderungen abgestimmt sind.

### Ihre Vorteile

- Höhere Schnittgeschwindigkeiten
- Schneller direkt auf Fertigmaß erodieren
- Reduzierung der Sekundärerosion
- Hochqualitative Oberflächengüten
- Gute, reproduzierbare Werkstückgenauigkeiten
- Stabile Leitwerte des Dielektrikums
- Optimierung des Ionisierharzverbrauches
- Reduzierter Maschinenverschleiß
- Senkung des Wartungsaufwands





- MANN+HUMMEL Gesellschaften
- Gemeinschaftsunternehmen

## MANN+HUMMEL Standorte in Ihrer Nähe!

Unsere Vertriebsrepräsentanten in allen wichtigen Ländern Europas, Amerikas, Südamerikas und Asiens bieten Ihnen vorort umfassende Unterstützung. Wo auch immer Ihr Standort ist, wenn Sie Fragen haben oder eine Beratung wünschen, rufen Sie uns an oder schicken Sie uns eine E-Mail!

**England** (West Malling, Kent)  
Tel.: +44 1732 523533  
E-Mail: uk.info@mann-hummel.com

**Argentinien** (Buenos Aires)  
Tel.: +54 11 4208 1200  
E-Mail: info@mann-hummel.com.ar

**Australien** (Newington, NSW)  
Tel.: +61 2 9647 1700  
E-Mail: info@mann-hummel.com.au

**Frankreich** (Sartrouville)  
Tel.: +33 2 43 49 73 74  
E-Mail: marketing.si@mann-hummel.com

**Brasilien** (Indaiatuba-SP)  
Tel.: +55 19 3894 94 00  
E-Mail: marketec@mann-hummel.com.br

**China** (Shanghai)  
Tel.: +86 21 6104 3222  
E-Mail: infomhcn@mann-hummel.com

**Italien** (Sondrio, SO)  
Tel.: +39 0342 2112 70  
E-Mail: it.info@mann-hummel.com

**Mexiko** (Santiago de Querétaro)  
Tel.: +52 442 103 1100  
E-Mail: infomx@mann-hummel.com

**Indien** (Bangalore)  
Tel.: +91 80 4020 7100  
E-Mail: office.india@mann-hummel.com

**Russland** (Moskau)  
Tel.: +7 495 742 7976  
E-Mail: info.ru@mann-hummel.com

**USA / Kanada** (Portage MI)  
Tel.: +1 (269) 329-7200  
E-Mail: info-us@mann-hummel.com

**Japan** (Yokohama)  
Tel.: +81 (45) 470-4588  
E-Mail: info.jp@mann-hummel.com

**Spanien / Portugal** (Zaragoza)  
Tel.: +34 (976) 287 300  
E-Mail: mhes@mann-hummel.com

**Korea** (Seoul)  
Tel.: +82 (2) 2059 5781  
E-Mail: info.kr@mann-hummel.com

**Tschechische Republik** (Okříšky)  
Tel.: +420 568 898 111  
E-Mail: cz.info@mann-hummel.com

**Singapur**  
Tel.: +65 6586 8181  
E-Mail: mhsg@mann-hummel.com



**MANN+HUMMEL GMBH**, Geschäftsbereich Industriefilter  
67346 Speyer, Germany, Telefon +49 (62 32) 53-80, Fax +49 (62 32) 53-88 99  
E-Mail: edm.info@mann-hummel.com, Internet: www.mann-hummel.com





## **MANN+HUMMEL EDM Filters**

**Technical know-how for EDM technology**





## Keeping up with international competitors

Tight schedules and pressure on costs combined with high quality specifications and complex components all mean that today producers of tools and moulds are subject to demanding requirements. In order to keep up with international competitors and consolidate a leading position it is necessary to have products which satisfy the complex requirements of electrical discharge machining. The increasing pressure to create new products and simultaneously improve reliability and availability underlines the importance of fully integrated production solutions in the field of EDM.

MANN+HUMMEL has many years of experience developing and producing highly efficient filter elements for EDM machines. In cooperation with major EDM machine producers we have been able to produce a large number of customised filter elements for many varied applications.

This has been made possible by our in-house development and testing laboratories with their special testing equipment. Comprehensive functional tests under real operating conditions right up to the validation of OE filters enable us to consistently provide our customers with first class EDM filters.



Validation in the MANN+HUMMEL testing laboratory





## Development and production expertise

MANN+HUMMEL offers a range of 150 mm diameter plastic EDM filters and is the only manufacturer worldwide to completely do without any adhesive or metal. Using modern butt-welding technology, the filter bellows is welded directly to the plastic end cap and forms a permanently sealed connection. This design concept reliably removes any undesired chemical influences on the dielectric fluid and thereby ensures the stability of the EDM process.

Modern development methods have enabled the improvement of the connection and inflow areas in the end caps of large-size filters. This design enables production of the plastic parts with low stress and low torsion using a gas assisted injection moulding process.

Further benefits for EDM filtration are that the filters have a consistent flow, the filter bellows are continuously loaded and the service life is improved.

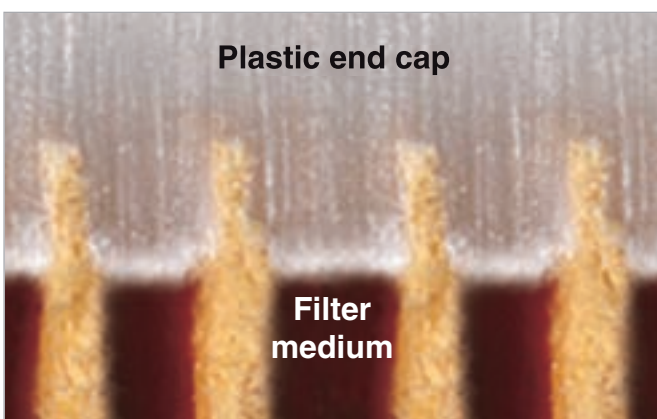

Adhesive-free joining techniques using butt-welding

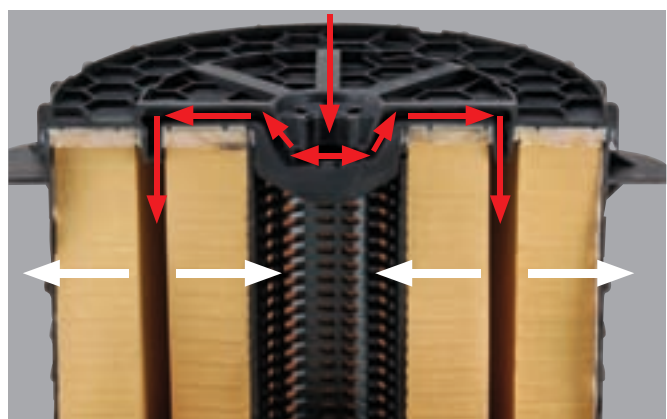

End caps with improved flow design

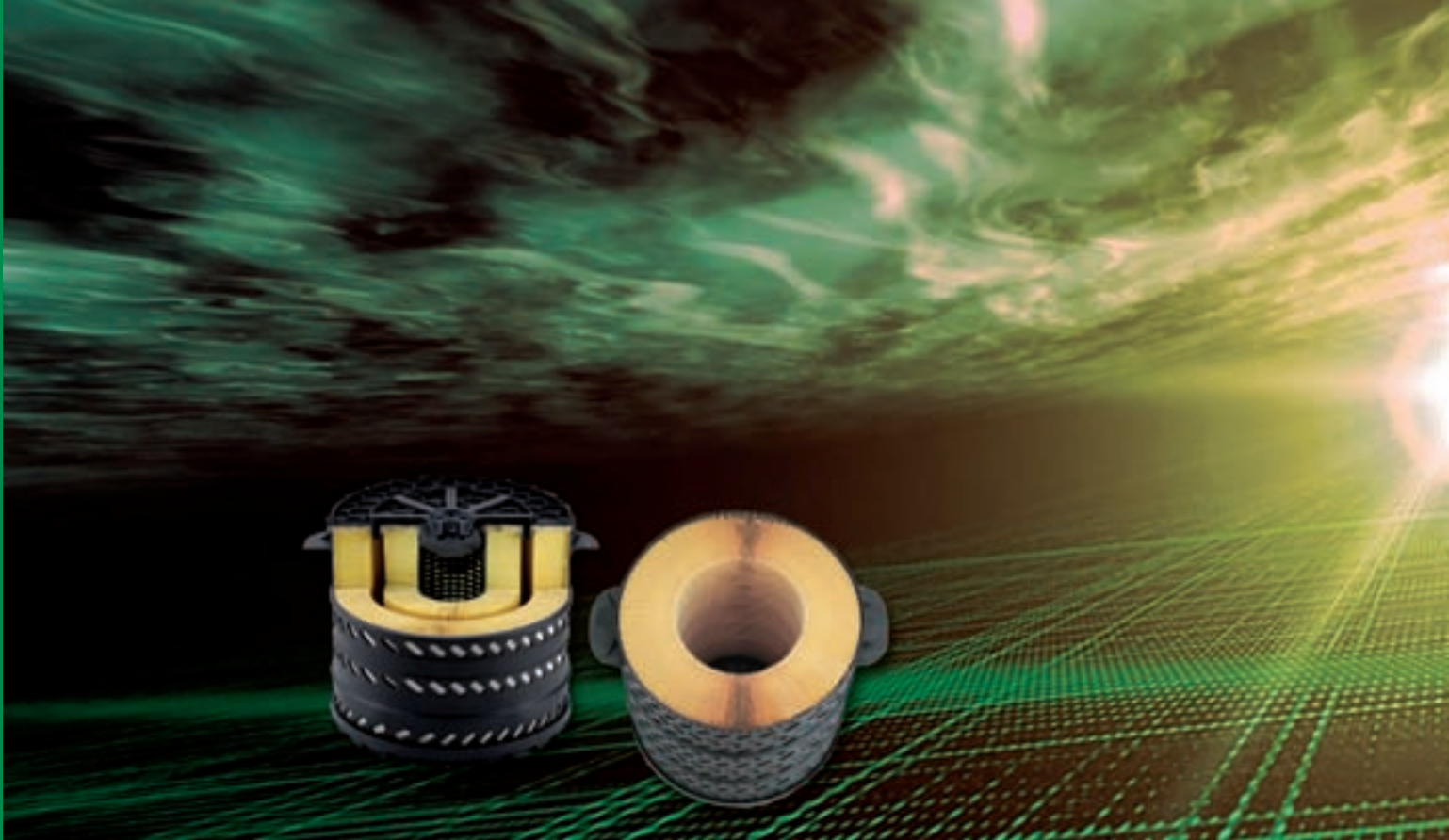

## High expertise in media and filtration technology

Modern testing methods in the development phase make for a comprehensive range of filter media. Filter finenesses of 1-2, 3-5, 10 and 25 microns with different cellulose and mixed fibre media offer the right solution for each respective machining material. In addition, the filter media are impregnated and hardened. This results in filtration paper which is highly resistant to pressure and water.

### Extending capacity

Different bellows technologies are available to achieve a higher filtration surface and performance. Macropleating technology uses enlarged end pleats with a height of 75 mm. Double bellows technology with a pleat height of 2 x 48 mm exploits the installation space to the maximum and increases the dirt holding capacity. In comparison to standard filters these two technologies add to the filter efficiency and service life.

SEM micrograph of filter media



Joachim Stinzendörfer,  
Media Development  
MANN+HUMMEL Industrial Filters



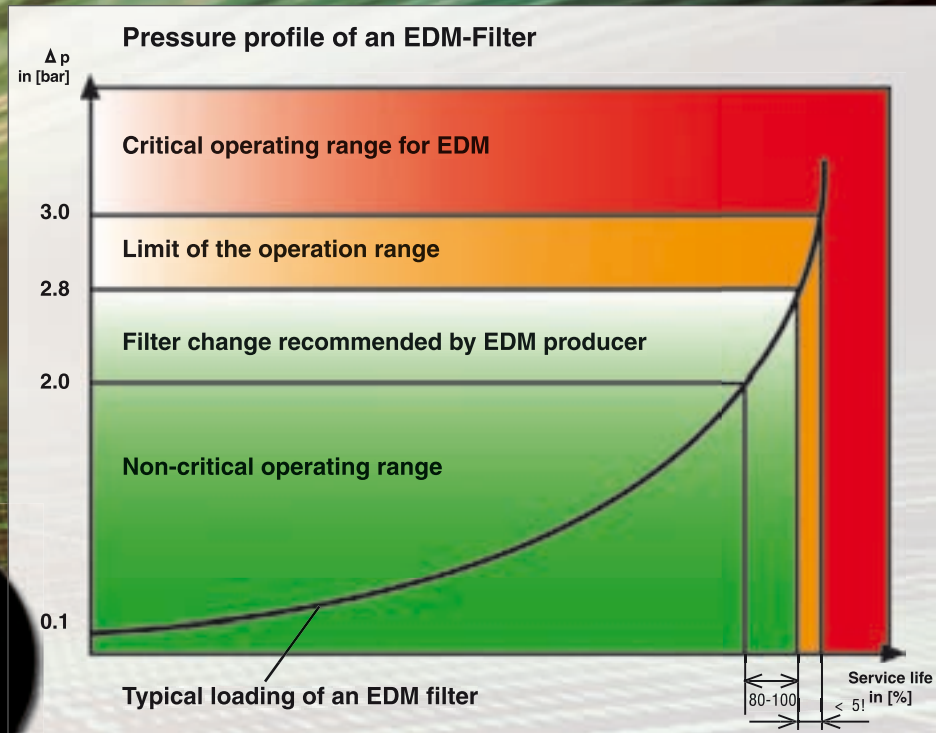

## Reliability through pressure stability

A pressure stability test for a filter producer is as important as a brake test for an automotive supplier. And just as the automotive industry is concerned with the safety of its customers, we want to offer long-term and reliable EDM filtration to our customers. MANN+HUMMEL EDM filters are therefore designed for a short-term differential pressure of 3 bar.

### What happens to the filter as the pressure increases?

As the particle load increases the differential pressure in the EDM filter rises over proportionally (see figure). This increases the internal pressure in the filter much faster at the end of its service life than at the beginning, i.e. towards the limit of the operating range the filter can only be further used for a short time. If this range is exceeded, this could result in damage to the EDM machine.

### Be on the safe side

In order to protect the filter system from permanently high pressure and ensure process reliability, the permissible operating pressure on the machine side is in the range of 2 to 2.8 bar. Even if MANN+HUMMEL EDM filters offer a safety reserve of up to 3 bar for a short period, the specifications of the EDM machine producer are always authoritative for the long-term reliable operation of the EDM machine.



3 bar = 0.3 MPa = 43.5 psi

max. 3 bar

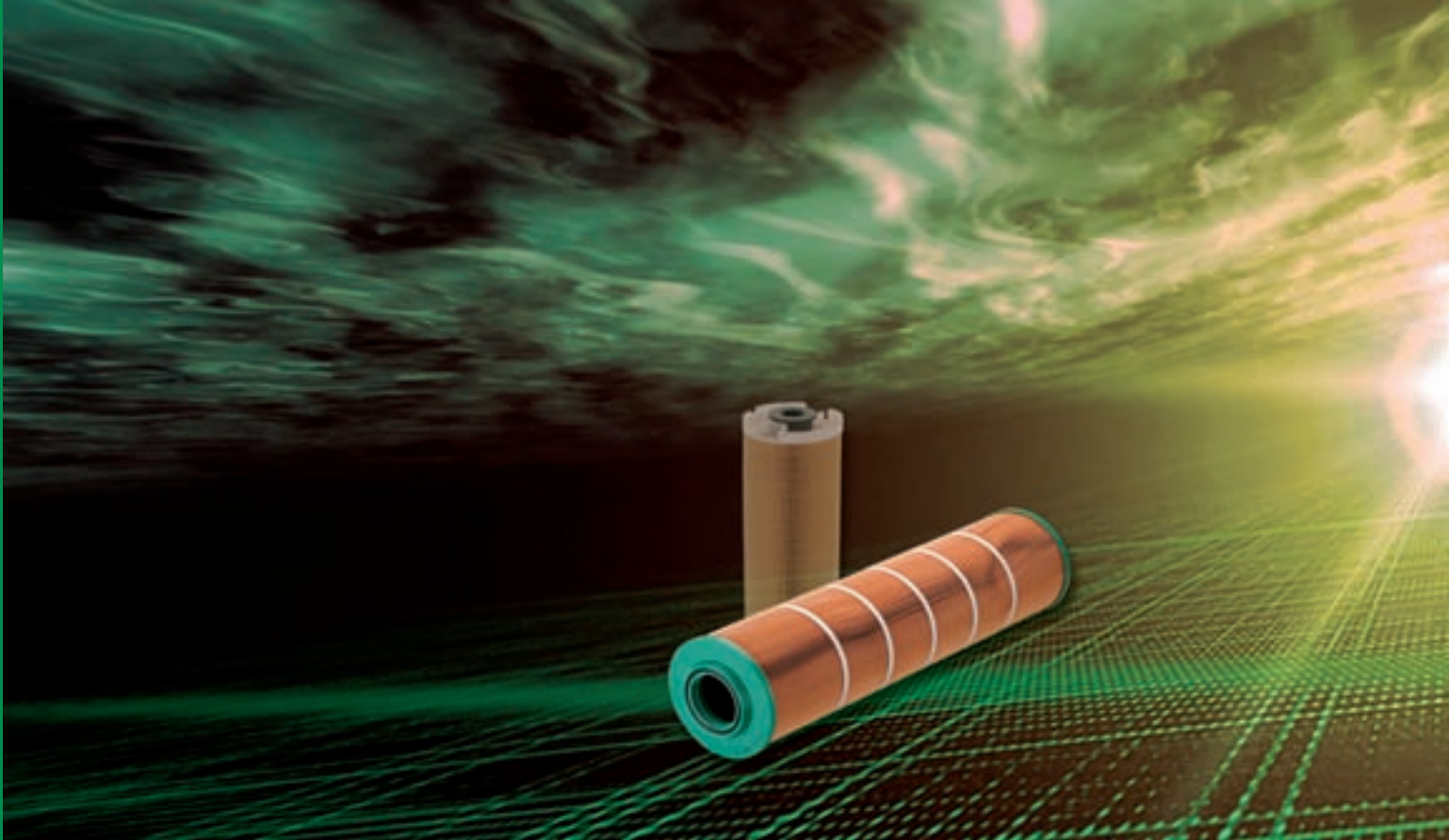

## Plug & Play - more than just filters

The MANN+HUMMEL range of filters gives you the highest standard for precision and flexibility. The comprehensive range of filters is complemented by an extensive selection of accessories.

Our filter solutions incorporate products proven in the field which are especially selected for their easy handling and operation.

MANN+HUMMEL therefore offers you exactly the flexibility necessary for the most varied process requirements in the field of EDM filtration.

**And all from a single source.**







## Top technology for top results

You benefit from a technological advantage through our expertise in EDM filtration. You can take advantage of highly efficient MANN+HUMMEL EDM filter elements which are exactly matched to the market requirements.

### Your advantages

- Higher cutting speeds
- Faster wire cutting to the final dimension
- Reduction of secondary erosion
- High quality surface finish
- Good, reproducible workpiece accuracy
- Stable conductance of the dielectric fluid
- Reduced consumption of the ionisation resin
- Reduced machine wear
- Reduced maintenance costs





● MANN+HUMMEL Companies

● Joint ventures

## MANN+HUMMEL locations near you!

Our sales representatives in all the major countries of Europe, America, South America and Asia will provide you with comprehensive support on site. Wherever your location, if you need further information or if you have any questions, simply call us or send us an email!

**UK** (West Malling, Kent)  
Tel.: +44 1732 523533  
Email: uk.info@mann-hummel.com

**France** (Sartrouville)  
Tel.: +33 2 43 49 73 74  
Email: marketing.si@mann-hummel.com

**Italy** (Sondrio, SO)  
Tel.: +39 0342 2112 70  
Email: it.info@mann-hummel.com

**Russia** (Moscow)  
Tel.: +7 495 742 7976  
Email: info.ru@mann-hummel.com

**Spain / Portugal** (Zaragoza)  
Tel.: +34 (976) 287 300  
Email: mhes@mann-hummel.com

**Czech Republic** (Okříšky)  
Tel.: +420 568 898 111  
Email: cz.info@mann-hummel.com

**Argentina** (Buenos Aires)  
Tel.: +54 11 4208 1200  
Email: info@mann-hummel.com.ar

**Brazil** (Indaiatuba-SP)  
Tel.: +55 19 3894 94 00  
Email: marketec@mann-hummel.com.br

**Mexico** (Santiago de Querétaro)  
Tel.: +52 442 103 1100  
Email: infomx@mann-hummel.com

**USA / Canada** (Portage MI)  
Tel.: +1 (269) 329-7200  
Email: info-us@mann-hummel.com

**Australia** (Newington, NSW)  
Tel.: +61 2 9647 1700  
Email: info@mann-hummel.com.au

**China** (Shanghai)  
Tel.: +86 21 6104 3222  
Email: infomhcn@mann-hummel.com

**India** (Bangalore)  
Tel.: +91 80 4020 7100  
Email: office.india@mann-hummel.com

**Japan** (Yokohama)  
Tel.: +81 (45) 470-4588  
Email: info.jp@mann-hummel.com

**Korea** (Seoul)  
Tel.: +82 (2) 2059 5781  
Email: info.kr@mann-hummel.com

**Singapore**  
Tel.: +65 6586 8181  
Email: mhsg@mann-hummel.com



**MANN+HUMMEL GMBH**, Industrial Filters Business Unit  
67346 Speyer, Germany, Tel.+49 (62 32) 53-80, Fax +49 (62 32) 53-88 99  
Email: edm.info@mann-hummel.com, Internet: www.mann-hummel.com





**Mit der Umwelt  
im Gleichgewicht**



**MANN+HUMMEL Kunststofffilterelemente  
für Erodiermaschinen**





## MANN+HUMMEL und Umweltschutz

Die wachsenden globalen Umweltprobleme haben in den letzten Jahren zu einer breiten Sensibilisierung in Bezug auf Umwelt- und Naturschutz geführt. MANN+HUMMEL ist sich seiner ökonomischen, ökologischen und gesellschaftlichen Verantwortung bewusst und hat sich mit seinem **Umweltmanagementsystem** verpflichtet, seine Produkte ständig zu optimieren.

Bei der Entwicklung der metallfreien EDM-Filterbaureihen standen die Inhalte dieses Umweltmanagementsystems im Vordergrund. So steht z.B. der vollständige Verzicht auf Metallkomponenten für einen verantwortungsvollen, effizienten Ressourceneinsatz. Zudem setzt MANN+HUMMEL ausschließlich modernste Verfahren in Entwicklung und Produktion sowie umweltfreundliche und energetisch verwertbare Materialien ein.



Eine runde Sache - für die Umwelt und in der Anwendung: MANN+HUMMEL Kunststofffilter schonen die Umwelt und Ihren Geldbeutel.

Endscheiben, Mittelrohr und Außenmantel sind zu 100% aus umweltfreundlichem Kunststoff.





## Die Bauform macht den Unterschied

**Traditionelle EDM-Filterelemente** bestehen meist aus einem Metallaußenmantel und Metallinnenrohr, einem innenliegenden Filterbalg sowie den beiden mit Klebstoff verbundenen Metallendscheiben.

Daneben gibt es **hybride Bauformen**, deren Gehäuse aus einem Metall-Kunststoff-Mix bestehen.

**MANN+HUMMEL Kunststofffilter sind komplett metallfrei und sortenrein.** Alle Kunststoffeingleile sind form- und gewichtsoptimiert und werden effizient im Spritzgussverfahren hergestellt.

**Ein doppeltes Plus für die Umwelt:** Modernste Produktionsverfahren und die spätere einfache Entsorgung schonen Ressourcen und entlasten die Umwelt.

### Aufbau Hybridfilter

Kunststoff-endscheiben

Kunststoff-innenrohr

Metallaußenmantel



### Aufbau MANN+HUMMEL Kunststofffilter

Kunststoff-endscheiben

Kunststoff-innenrohr

Kunststoffaußenmantel





Hybrid- oder Metallfilterelemente

MANN+HUMMEL Kunststofffilterelemente

**Umweltbewusst denken,  
verantwortungsvoll  
handeln:**

**„Schwergewichtige“  
Argumente für  
MANN+HUMMEL  
Kunststofffilterelemente!**

**Werkstoffliche Entsorgung**

**(z.B. Hybrid- oder Metallfilterelemente)**

- Schreddern
- Zentrifugieren
- Material trennen nach:
  - Metall
  - Kunststoff, Gummi
  - Papier
- Metall dem Recycling zuführen
- Kunststoff und Gummi thermisch behandeln

**Hoher Aufwand bezüglich:**

- Energie
- Logistik
- Prozess

**Energetische Entsorgung**

**(MANN+HUMMEL  
Kunststofffilterelemente)**

Die beladenen Filterelemente werden komplett thermisch verwertet, d.h. in geeigneten Anlagen der Stahlindustrie, in Zementwerken oder in Müllverbrennungs-Kraftwerken als zusätzlicher Energieträger zugeführt und rückstandsfrei verbrannt.

Ökonomisch und ökologisch betrachtet ist die thermische Verwertung von sortenreinen Elementen die bessere Lösung!





## Umweltbewusst denken...

### Karin Knödler

Leiterin Teile- & Materialservice (TMS),  
Agie Charmilles GmbH, Schorndorf

„Als einer der führenden Erodiermaschinenhersteller hat GF AgieCharmilles das Ziel, die vielfältigen Bedürfnisse unserer Kunden durch Qualitätsprodukte zu befriedigen und gleichzeitig wirtschaftlich und gesellschaftlich verantwortlich zu handeln. Mit MANN+HUMMEL verbindet uns eine langjährige Leistungspartnerschaft, die sich durch innovative Produkte und fachkompetente Betreuung auszeichnet. Ein wichtiger Fortschritt sind für uns die umweltgerechten Erodierfilter, mit denen wir aktiv unseren Beitrag für eine saubere Umwelt leisten möchten.“



## ...und verantwortungsvoll handeln!

### Stefan Kempf

Geschäftsfeldleiter Umweltmanagement und Beratung der TÜV Rheinland Group, Kaiserslautern



„Im Auftrag von MANN+HUMMEL haben wir die abfallrechtlichen Vorgaben zur ordnungsgemäßen Entsorgung von Kunststoff-EDM-Filtern recherchiert und zusammengestellt.

Unser Gutachten belegt, dass aufgrund des Heizwertes der EDM-Kunststofffilter eine thermische Verwertung sinnvoll und empfehlenswert ist.

Das umweltgerechte Filterkonzept schont in zweierlei Hinsicht wertvolle Ressourcen: Zum einen als teilweiser Ersatz von Primärbrennstoffen wie Kohle oder Öl und zum anderen bei der direkten Erzeugung von Wärme, Dampf oder Strom in Müllverbrennungsanlagen.“



## Sortenrein, kunden- und umweltbewusst!

### Das MANN+HUMMEL Kunststofffilterprogramm mit vielen Pluspunkten:

- Vollständiger Verzicht auf Korrosionsschutz wie z.B. Lacke oder Pulverbeschichtungen
- Material- und bauformoptimierte Herstellung der Kunststoffeingleile durch effiziente Spritzgusstechnologie
- Rückstandsfreie, thermische Verwertung durch sortenreine, metallfreie Bauform
- Energieersparnis in thermischen Verwertungsprozessen durch einen Heizwert ähnlich wie Heizöl
- Keine Materialtrennung oder Zwischenverarbeitung wie beim klassischen Recycling erforderlich
- Bis zu 30% Gewichteinsparung, dadurch leichteres Handling und reduzierter Transportaufwand



**MANN+HUMMEL GMBH**, Geschäftsbereich Industriefilter  
67346 Speyer, Germany, Telefon +49 (62 32) 53-80, Fax +49 (62 32) 53-88 99  
E-Mail: [edm.info@mann-hummel.com](mailto:edm.info@mann-hummel.com), Internet: [www.mann-hummel.com](http://www.mann-hummel.com)





**In Harmony  
with the Environment**

**MANN+HUMMEL Plastic filter elements  
for EDM machines**





## MANN+HUMMEL and environmental protection

Increased environmental problems in recent years around the world have led to an increase in public awareness of environmental concerns and nature. MANN+HUMMEL is aware of its economic and ecological responsibility to society. Accordingly, we are committed to an **environmental management system** dedicated to the continual improvement of our products.

During the development of our metal-free EDM filter series the content of this **environmental management system** was our top priority. As a result, we have completely eliminated the need for metal components, which is a responsible and efficient use of resources. In addition, MANN+HUMMEL uses modern development and production processes with the emphasis on materials which are environmentally friendly and energetically reusable.



A great thing - for the environment and your application: MANN+HUMMEL plastic filters conserve the environment and your financial resources.

End caps, centre tube and external housing are 100% made of environmentally-friendly plastic.





## The difference is in the design

**Traditional EDM filter elements** usually consist of an external housing of metal with a metal centre tube, an internal filter bellow and the two metal end caps bonded with adhesive.

Furthermore there are also **hybrid designs** available with housings in metal and plastic.

**MANN+HUMMEL plastic filters** are made of homogeneous plastic and completely free of metal.

The shape and weight of all the plastic components has been optimised and the parts are efficiently produced in an injection moulding process.

**A double bonus for the environment:** A modern production process and the easy disposal of the product afterwards conserve resources and support the environment.

Design of hybrid filter

Plastic end caps

Plastic centre tube

Metal external housing



Design of MANN+HUMMEL filter

Plastic end caps

Plastic centre tube

Plastic external housing

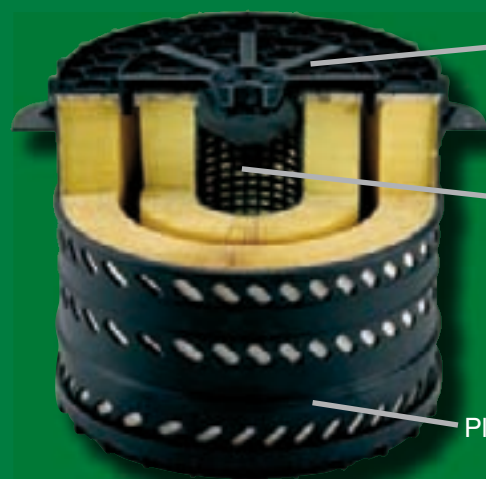



Hybrid or metal filter elements

MANN+HUMMEL plastic filter elements

**Be environmentally-conscious and act responsibly:**

**Many benefits tip the scale towards the use of MANN+HUMMEL plastic filter elements**

### Disposal of material

(e.g. hybrid or metal filter elements)

- Shred
- Centrifuge
- Separate material according to:
  - Metal
  - Plastic, rubber
  - Paper
- Send metal to be recycled
- Thermally treat plastic and rubber

High costs for:

- Energy
- Logistics
- Process

### Incineration disposal - energetic value

(MANN+HUMMEL plastic filter elements)

The loaded filter elements are completely thermally disposed, i.e. are used in appropriate systems in the steel industry, in cement works or in waste incineration power stations as an additional source of energy and incinerated without leaving any deposits.

In economic and ecological terms the thermal disposal of plastic filter elements is the best solution!





## Be environmentally-conscious...

### Karin Knödler

Head of Spares and Consumables at Agie Charmilles GmbH, Schorndorf, Germany

“As one of the leading manufacturers of EDM machines, the aim of GF AgieCharmilles is to satisfy the varied requirements of our customers by using quality products while simultaneously acting in a responsible way towards society. MANN+HUMMEL is a long-term high performance partner for us and excels with innovative products and a high degree of technical competence. The development of environmentally-compatible EDM filters is an important step for us as it allows us to make an active contribution towards a clean environment.”



## ...and act responsibly!

### Stefan Kempf

Head of the Business Unit “Environmental Management and Consulting” at the technical inspection agency “TÜV Rheinland Group” Kaiserslautern, Germany



“MANN+HUMMEL commissioned us to do research in the field of waste specifications for the correct disposal of plastic EDM filters. Our report documents that, due to the calorific value of plastic filters, thermal disposal makes sense and is recommendable.

This environmentally friendly filter concept conserves valuable resources in two ways. Firstly it partly replaces primary fuels such as coal or oil and secondly it generates heat, steam or power in waste incineration plants.”



**Homogeneous plastic material, customer-friendly and environmentally compatible!**

**The MANN+HUMMEL plastic filter range with many advantages:**

- Corrosion protection with paint or powder coatings no longer necessary
- Efficient plastic parts production through the use of modern injection moulding technologies
- Incineration disposal through the use of 100% plastic filters
- Disposal process offers renewable energy source similar to common heating oil
- No material separation or intermediate processing as is required with classic recycling
- Up to 30% weight saving enabling easier manual handling and lower transportation costs



























**MANN+HUMMEL GMBH**, Industrial Filters Business Unit  
67346 Speyer, Germany, Tel.+49 (62 32) 53-80, Fax +49 (62 32) 53-88 99  
E-Mail: [edm.info@mann-hummel.com](mailto:edm.info@mann-hummel.com), Internet: [www.mann-hummel.com](http://www.mann-hummel.com)



























## **Piktogrammübersicht / Pictogram overview**

# Piktogrammübersicht / Pictogram overview

Symbol						
	Bestellnr.	Part no.	No. de commande	Numero d'ordine	Referencia	Referência
	Draht-erosion	Wire EDM	Eléctro-érosion à fil	Elettroerosione a filo	Electroerosión por hilo	Electroerosão por fio
	Senk-erosion	Sinker EDM	Eléctro-érosion à enfonçage	Elettroerosione a tuffo	Electroerosión por penetración	Electroerosão por perfuração
	Filter-feinheit	Filter fineness	Finesse de filtration	Grado di filtrazione	Finura de filtración	Micragem
	Einfach-balg	Single bellow	Soufflet simple	Setto filtrante semplice	Fuelle simple	Fole simples
	Doppel-balg	Double bellow	Soufflet double	Doppio setto filtrante	Doble fuelle	Duplo fole
	Makro-falten	Macro pleats	Macro-plis	Macro pieghe	Macro-plegues	Macro pregas
	Adapter inklusive	Adapter included	Raccord inclus	Compreso di raccordo	Boquilla de conexión incluida	Inclui boquilha de conexão
	Innen nach außen	Inside to outside	De l'intérieur vers l'extérieur	Interno > Esterno	De dentro hacia fuera	De dentro para fora
	Außen nach innen	Outside to inside	De l'extérieur vers l'intérieur	Esterno > Interno	De fuera hacia dentro	De fora para dentro
	Kunststoff (metallfrei)	Plastic (metal-free)	Plastique (sans métal)	Senza metallo	Plástico (sin metal)	Plástico
	Metall	Metal	Métallique	Metallo	Chapa de acero	Chapa de aço
	Gewicht	Weight	Poids	Peso	Peso	Peso
	Benötigt Servicekit	Requires service kit	Service kit nécessaire	Necessita kit di manutenzione	Necesita kit de servicio	Precisa kit de serviço
	Zubehör (optional)	Optional accessories	Accessoires en option	Accessorio opzionale	Accesorios opcionales	Acessórios opcionais
	Messing	Brass	Laiton	Ottone	Latón	Latão
	Aluminium	Aluminium	Aluminium	Alluminio	Aluminio	Alumínio
	3-fach-Balg	Triple-bellow	triple soufflet	setto filtrante triplo	triple fuelle	triple fole



# Piktogrammübersicht / Pictogram overview

Symbol					
	Artikelnummer	Номер по каталогу	Zamówienie nr.	Kód	Parça No.
	Trådgnist	Проволочная эрозия	Erozja drutowa	EDM řezání drátem	Tel erozyon tezgahı
	Sänkgnist	Погружная эрозия	Erozja wgłębna	EDM hloubení	Dalma erozyon tezgahı
	Filtertäthet	Тонкость отсева	Dokładność filtra	Jemnost filtrace	Filtre hassasiyeti
	Enkelbälg	Одиная фильтрующая штора	Mieszek pojedynczy	Jednoduchý filtr	Tek kanallı
	Dubbelbälg	Двойная фильтрующая штора	Mieszek podwójny	Dvojitý filtr	Çift kanallı
	Makrotyg	Макро-складки	Makro zakładki	Makro sklady filtračního media	Plakalı tip
	Inklusive koppling	Включая адаптер	Zawiera szybkozłącze	Rychlospojka	Adaptörlü
	Insida till utsida	Изнутри наружу	Na zewnątrz	Směr toku zevnitř ven	İçeriden dışarıya doğru
	Utsida till insida	Снаружи внутрь	Do wnętrza	Směr toku zvenku dovnitř	Dışarıdan içeriye doğru
	Plast	Синтетический материал (без металла)	Obudowa z tworzywa	Filtr bez kovových částic	Plastik (Metal içermeyen)
	Metall	Листовая сталь	Obudowa stalowa	Kovový	Metal
	Vikt	Вес	Waga	Hmotnost filtru	Ağırlık
	Kräver service kit	Необходим комплект инструментов для ТО	Wymaga zestawu serwisowego	Potřeba servisní sady	Servis kiti ihtiyacı
	Valbart tillbehör	Дополнительное оборудование	Aksesoria opcjonalne	Nepovinné doplňky	Opsiyonel aksesuarlar
	Mässing	Латунь	Mosiądz	Mosaz	Pirinç
	Aluminium	Алюминий	Aluminium	Hliník	Aluminyum
	tre-zons-filter	Трёхсегментный	mieszek potrójny	trojitý filtr	Üçlü Pileleme

# Piktogrammübersicht / Pictogram overview

Symbol			
	품번	注文番号	订购号码
	와이어타입	ワイヤー 放電加工機	适用于线切割
	싱크타입	型彫り 放電加工機	适用于火花机
	여과정도	ろ過精度	过滤精度
	단일 여과지	シングル ペローズ	单排滤纸褶
	이중 여과지	ダブル ペローズ	双排滤纸褶
	대형 단일 여과지	マクロ プリーツ	宽型折纸方式
	어답터 포함	アダプター付	包含接嘴
	내압식	内圧式	内压式
	외압식	外圧式	外压式
	플라스틱 (비금속)	プラスチック (メタル フリー)	塑料 (非金属)
	금속	金属	金属
	무게	重量	重量
	서비스 킷	サービスキ ット必要	维护包
	악세서리 옵션	オプション (アクセサリ)	可选配件
	황동	黄銅(真鍮)	黄铜
	알루미늄	アルミニウム	铝
	3중 여과지	3分割ペローズ	三褶芯





**+GF + Agie Charmilles**

## +GF + Agie Charmilles

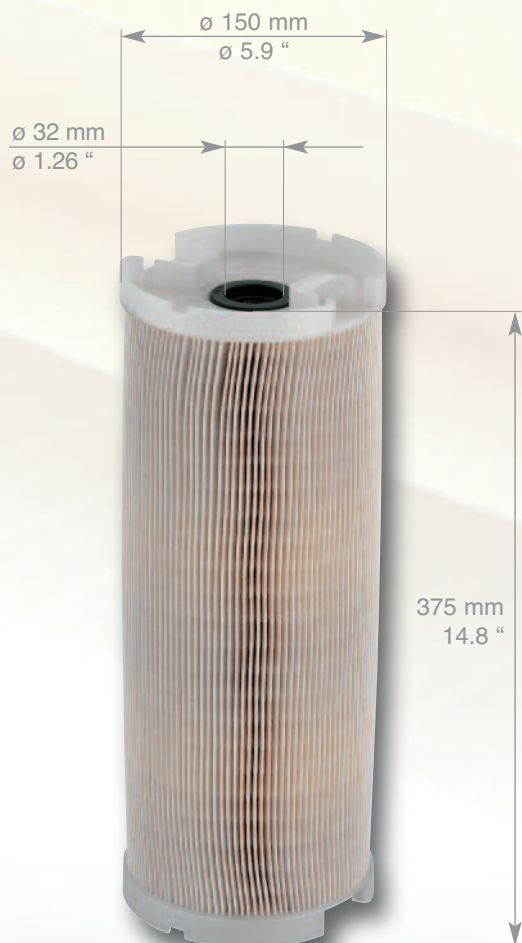

**H 15 190/1**



**1 - 2  $\mu\text{m}$**



**2,8 m<sup>2</sup> (30 ft<sup>2</sup>)**



**1,0 kg (2.2 lb.)**





## +GF + Agie Charmilles

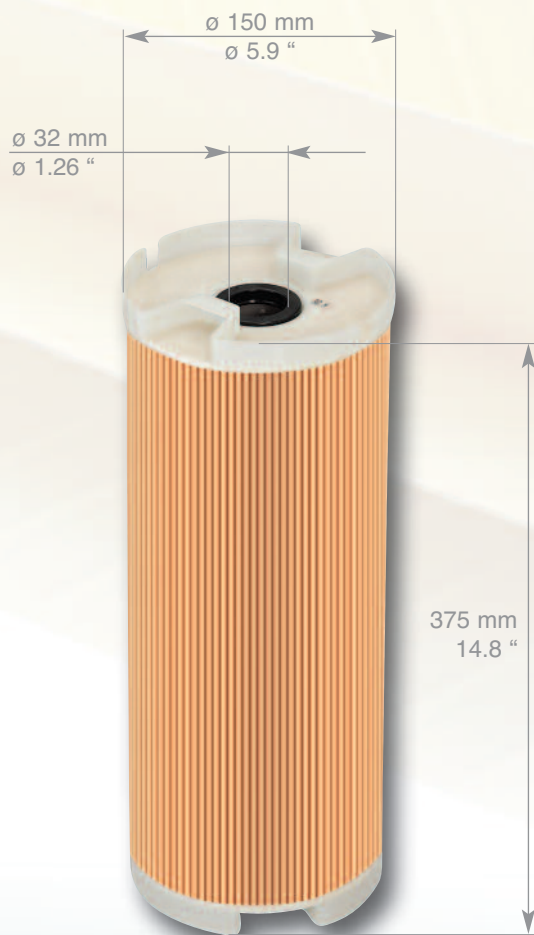

**H 15 190/16**



WEDM



EDM



**3 - 5  $\mu\text{m}$**



PL



**3,1  $\text{m}^2$  (33  $\text{ft}^2$ )**



KG

**0,8 kg (1.8 lb.)**



# +GF + Agie Charmilles



**H 15 190/6**



WEDM



EDM



**3 - 5  $\mu\text{m}$**



ST



**2,8 m<sup>2</sup> (30 ft<sup>2</sup>)**



KG

**1,5 kg (3.3 lb.)**



## +GF + Agie Charmilles



**E-Line**



WEDM



EDM



**3 - 5  $\mu\text{m}$**



PL



**2,7 m<sup>2</sup> (29 ft<sup>2</sup>)**



**0,7 kg (1.5 lb.)**



# +GF + Agie Charmilles

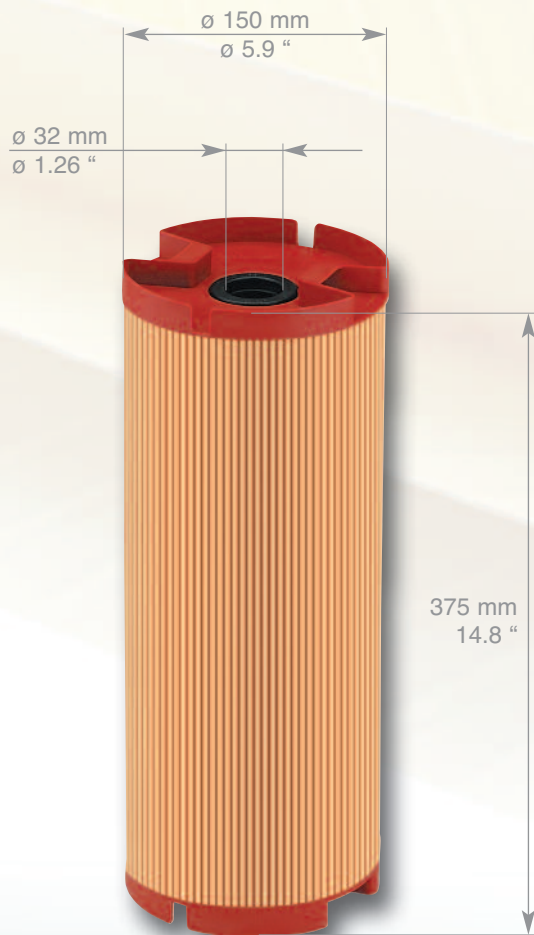

**H 15 475/1**



EDM



WEDM



**3 - 5  $\mu\text{m}$**



PL



**4,5 m<sup>2</sup> (49 ft<sup>2</sup>)**



KG

**0,9 kg (2.0 lb.)**





## +GF + Agie Charmilles



**H 15 475**

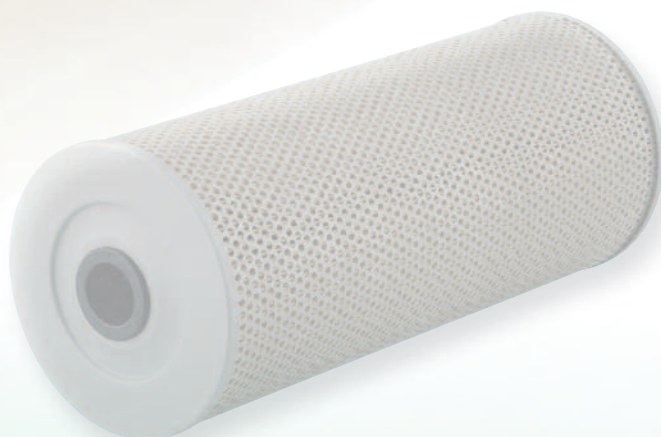

EDM



WEDM



**3 - 5  $\mu\text{m}$**



ST



**4,7 m<sup>2</sup> (51 ft<sup>2</sup>)**



KG

**1,7 kg (3.7 lb.)**

## +GF + Agie Charmilles



**H 15 190/10**



**10 µm**



**2,8 m<sup>2</sup> (30 ft<sup>2</sup>)**



**0,7 kg (1.5 lb.)**





## +GF + Agie Charmilles



**H 15 190**

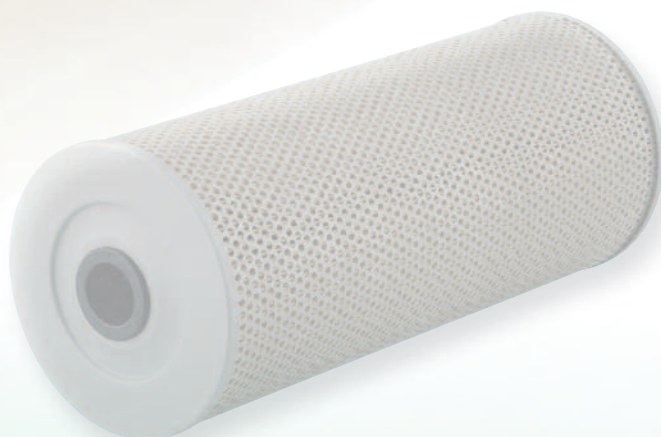

**10 µm**

**2,1 m<sup>2</sup> (22 ft<sup>2</sup>)**

**ST**

**1,4 kg (3.1 lb.)**

## +GF + Agie Charmilles

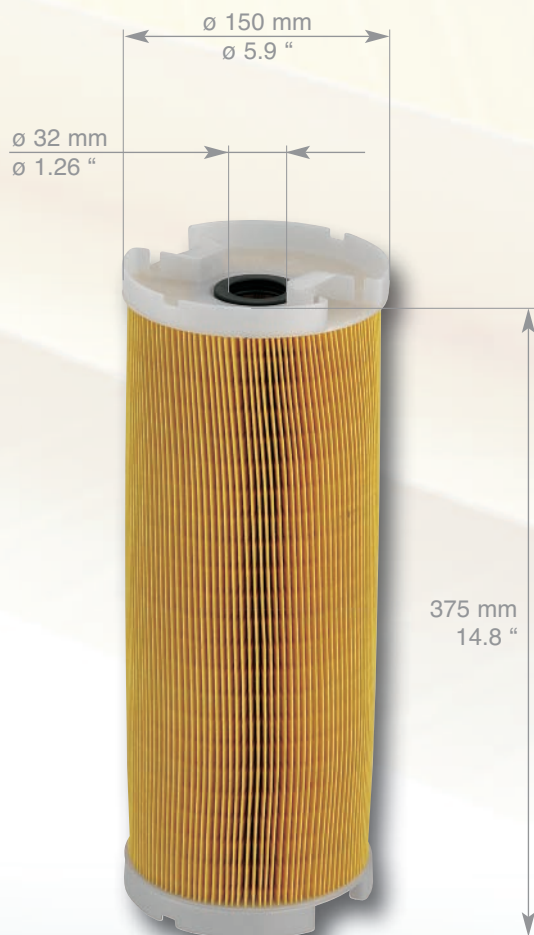

**H 15 190/25**



**25 µm**



**2,3 m<sup>2</sup> (25 ft<sup>2</sup>)**



**0,8 kg (1.8 lb.)**





# +GF + Agie Charmilles



**H 15 190/12**



**25  $\mu\text{m}$**

**2,2 m<sup>2</sup> (23 ft<sup>2</sup>)**



**1,4 kg (3.7 lb.)**

## +GF + Agie Charmilles

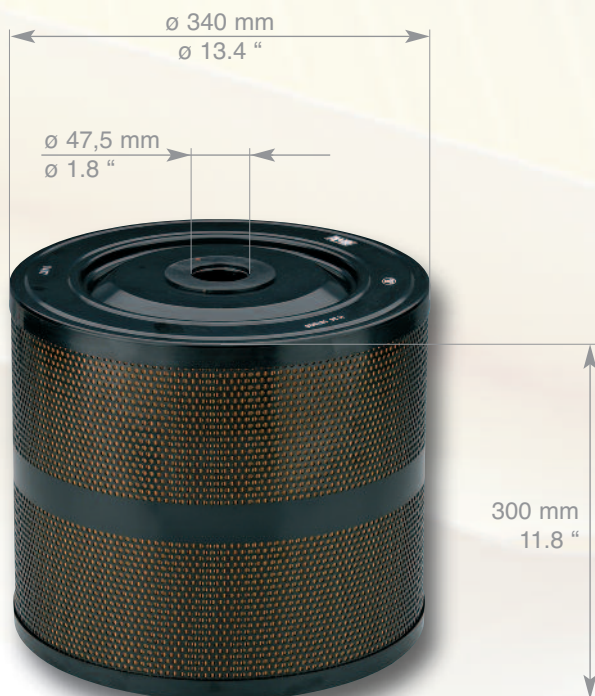

**H 34 1070/1**



WEDM



**1 - 2  $\mu\text{m}$**



ST



**9,2 m<sup>2</sup> (99 ft<sup>2</sup>)**



**6,5 kg (13.2 lb.)**



## +GF + Agie Charmilles

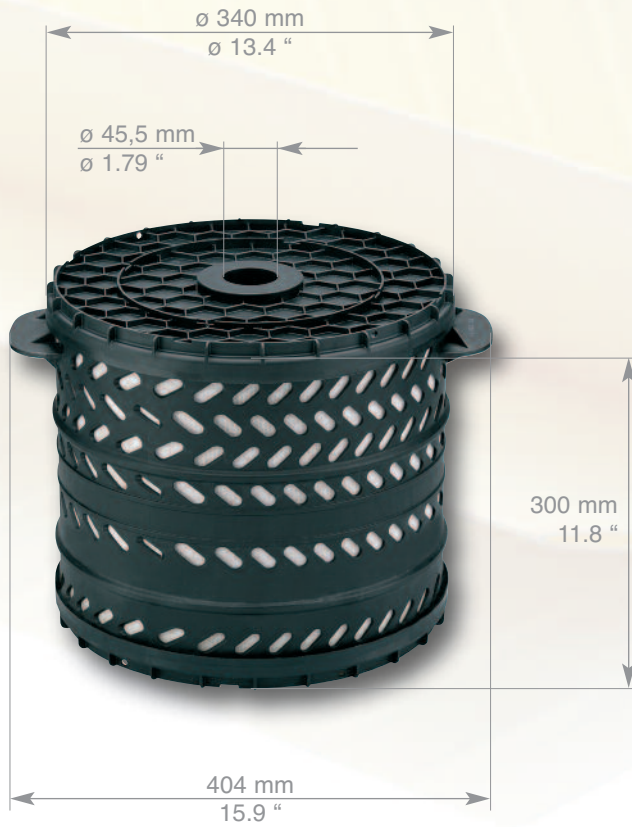

**H 34 1290/3**



WEDM



**3 - 5  $\mu\text{m}$**



PL



**10,5 m<sup>2</sup> (113 ft<sup>2</sup>)**



**6,2 kg (13.7 lb.)**

## +GF + Agie Charmilles

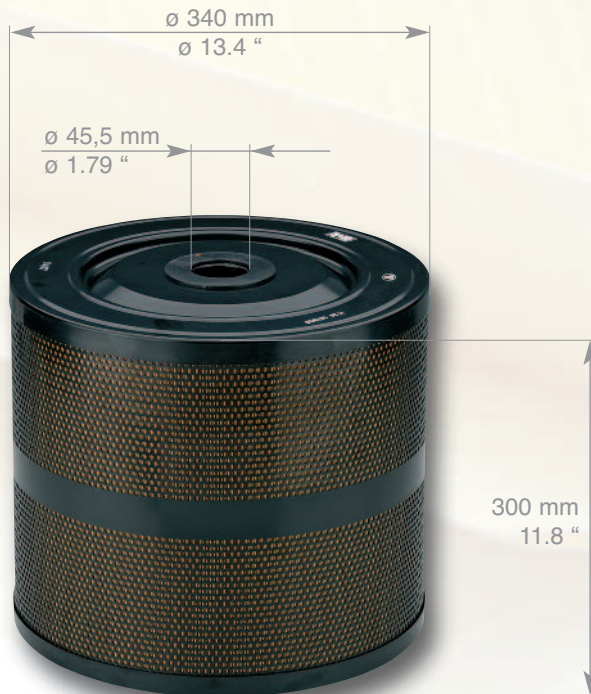

**H 34 1070/20**



**3 - 5  $\mu\text{m}$**



**10,7 m<sup>2</sup> (115 ft<sup>2</sup>)**



**6,4 kg (14.1 lb.)**



## +GF + Agie Charmilles

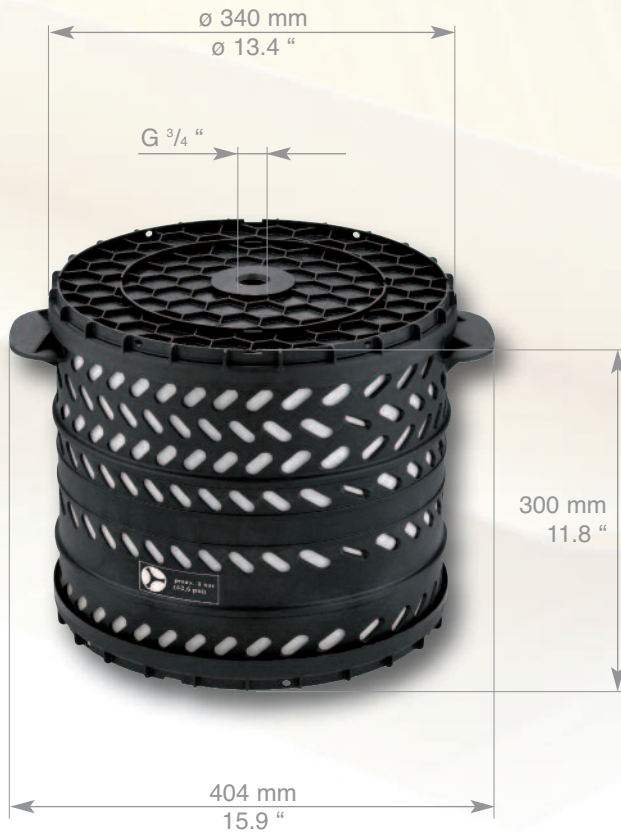

**H 34 1490/4 Kit**

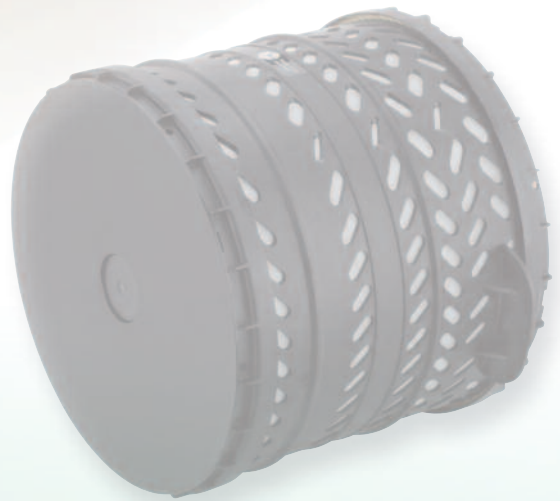

**1 - 2  $\mu\text{m}$**



**14,8 m<sup>2</sup> (159 ft<sup>2</sup>)**



**6,4 kg (14.1 lb.)**

## +GF + Agie Charmilles

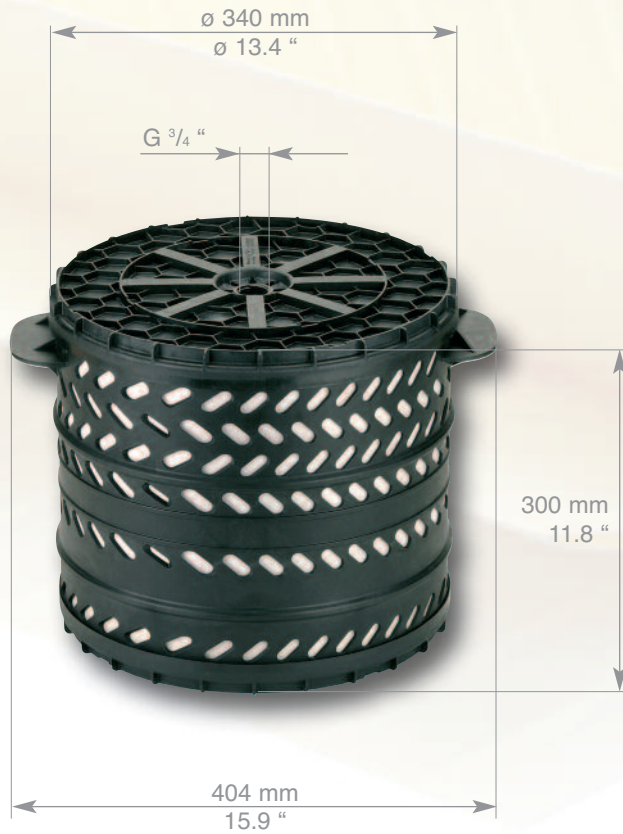

**H 34 1390/1**

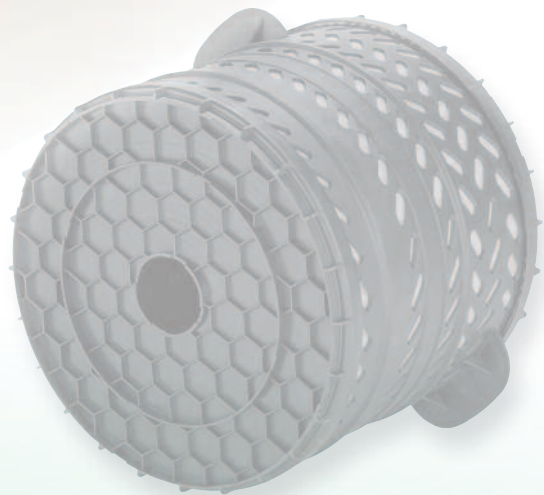

WEDM

**1 - 2  $\mu\text{m}$**

**13,5 m<sup>2</sup> (145 ft<sup>2</sup>)**



PL

**6,4 kg (14.1 lb.)**



## +GF + Agie Charmilles

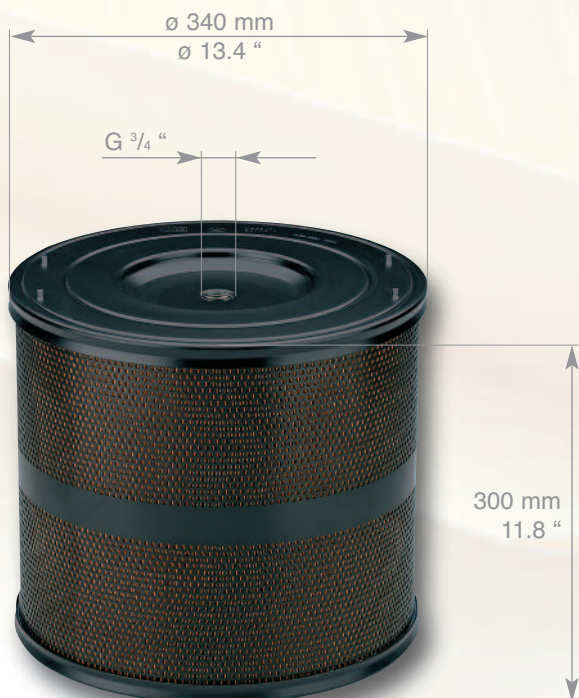

**H 34 1380/1**

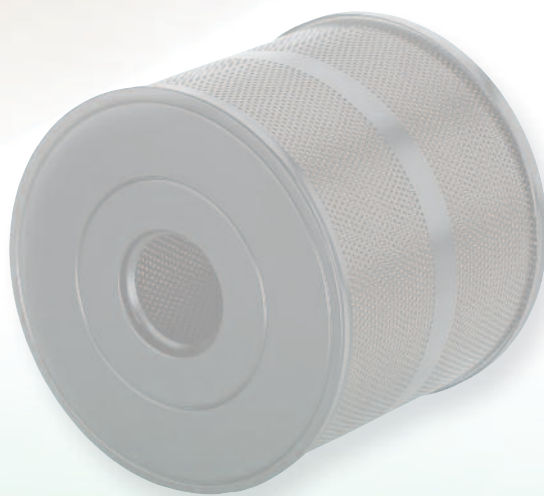

**1 - 2  $\mu\text{m}$**



**14,2 m<sup>2</sup> (153 ft<sup>2</sup>)**



**8,5 kg (18.7 lb.)**



## +GF + Agie Charmilles

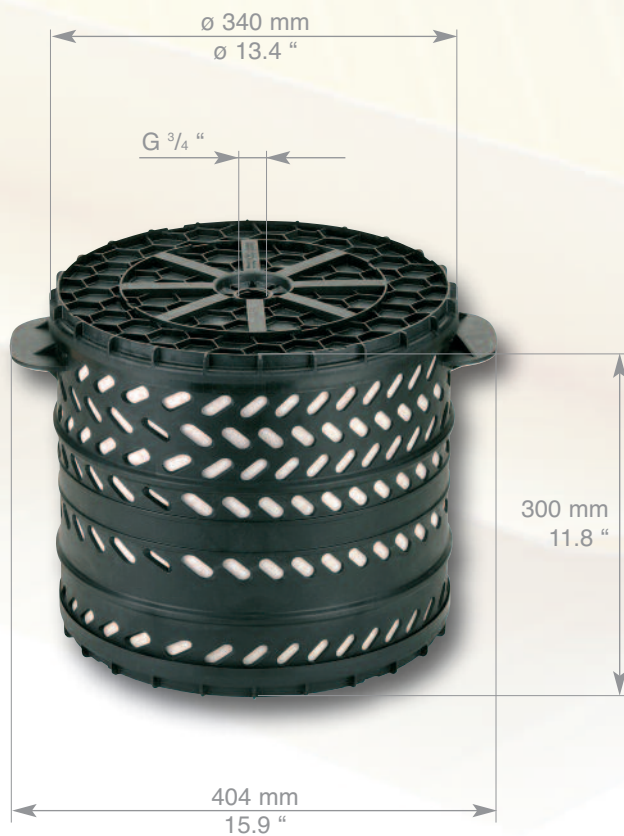

**H 34 1390**

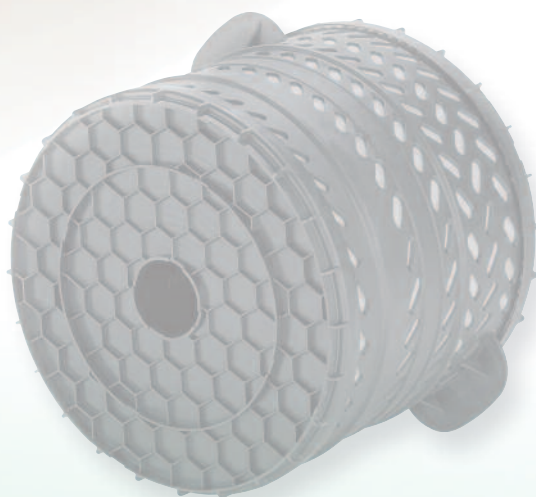

**3 - 5  $\mu\text{m}$**



**13,5 m<sup>2</sup> (145 ft<sup>2</sup>)**



**6,4 kg (14.1 lb.)**



## +GF + Agie Charmilles

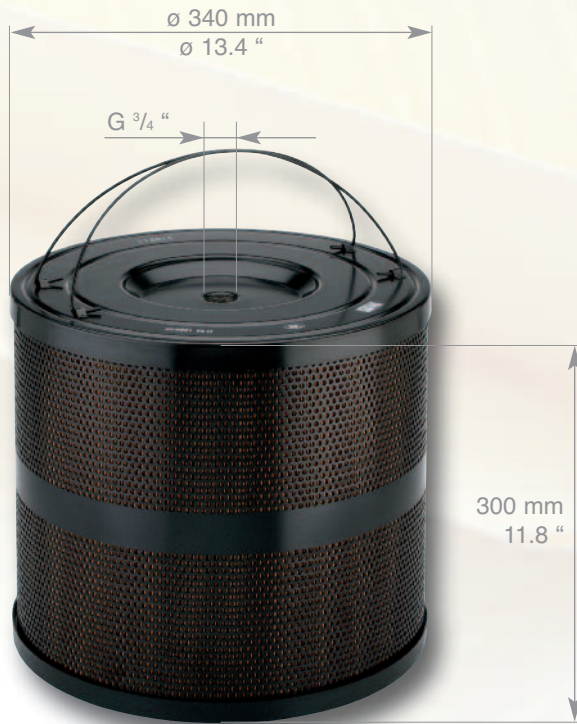

**H 34 1380/20 Kit**

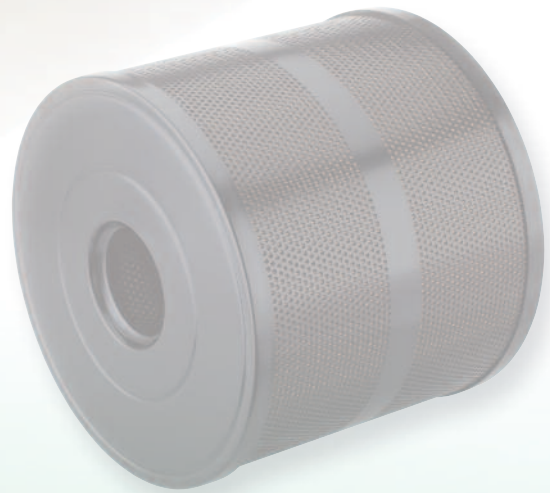

WEDM

**3 - 5  $\mu$ m**

**14,2 m<sup>2</sup> (153 ft<sup>2</sup>)**



ST

**8,5 kg (18.7 lb.)**

## +GF + Agie Charmilles

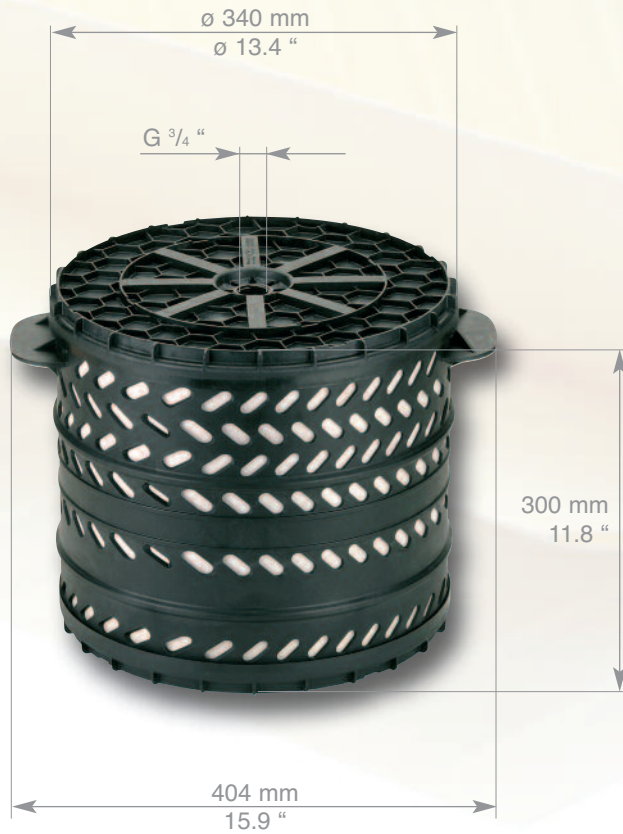

**H 34 1390/2**



**10  $\mu\text{m}$**



**12,8 m<sup>2</sup> (138 ft<sup>2</sup>)**



**5,7 kg (12.6 lb.)**



## +GF + Agie Charmilles

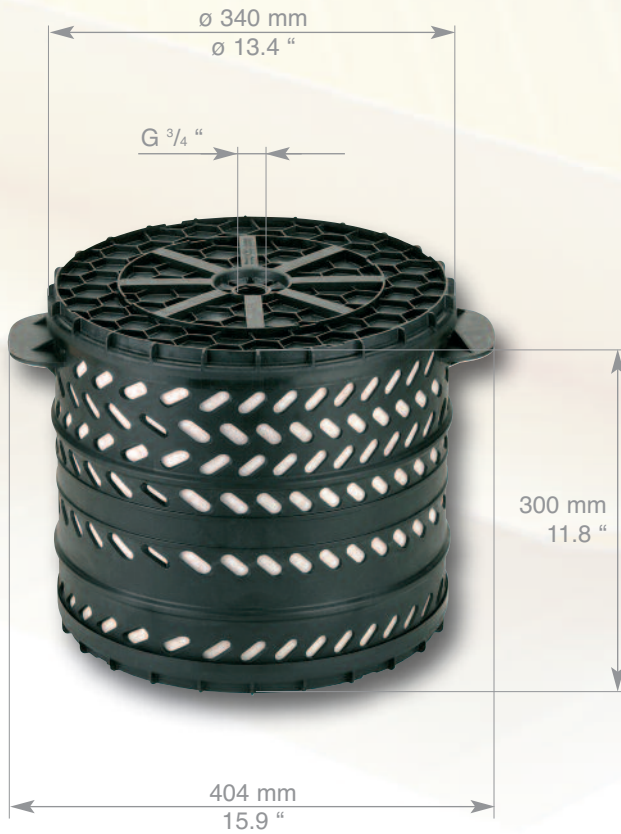

**H 34 1390/3**

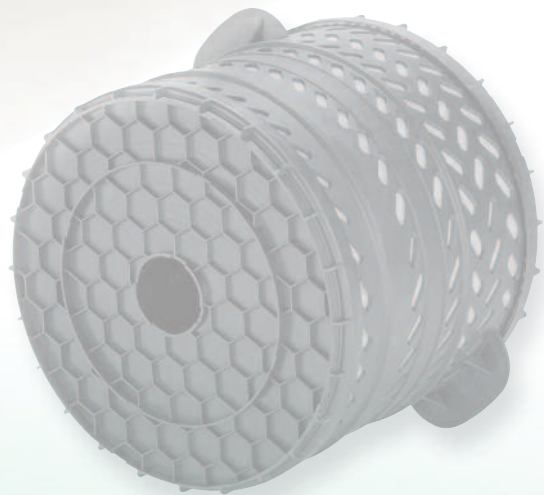

**25  $\mu\text{m}$**



**10,2 m<sup>2</sup> (110 ft<sup>2</sup>)**



**5,7 kg (12.6 lb.)**

## +GF + Agie Charmilles



**H 34 1790/3**

$\varnothing 47,5 \text{ mm}$   
 $\varnothing 1.87 \text{ ''}$

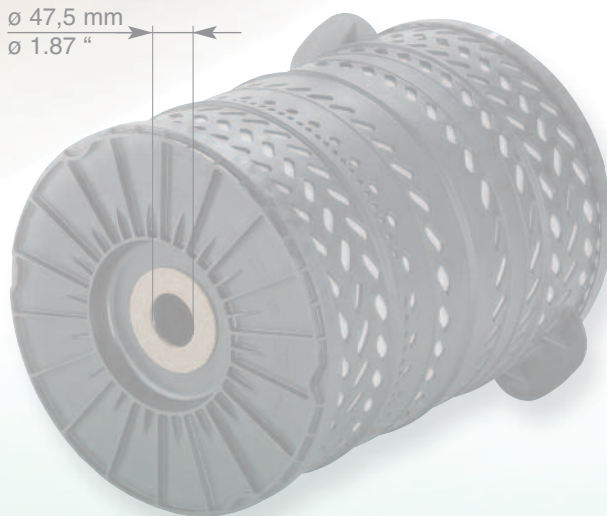

**3 - 5  $\mu\text{m}$**



**14,5 m<sup>2</sup> (156 ft<sup>2</sup>)**



**6,6 kg (14.6 lb.)**





## +GF + Agie Charmilles

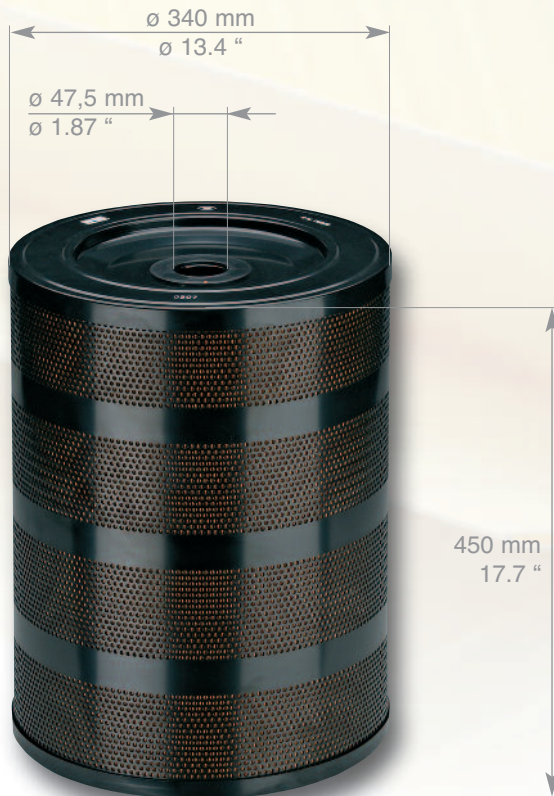

**H 34 1158/20**

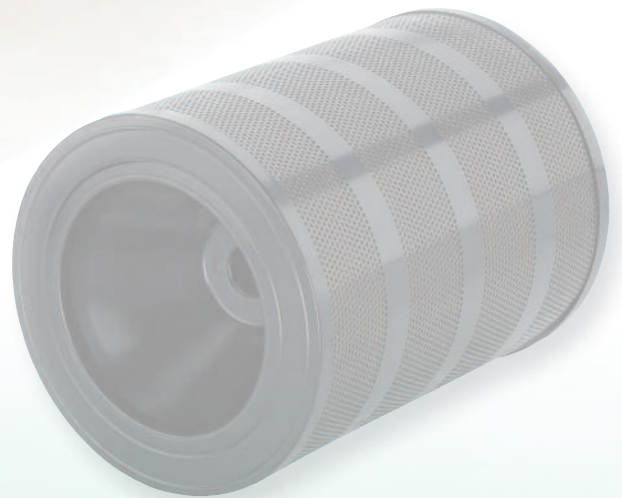

WEDM

**3 - 5  $\mu\text{m}$**

**14,5 m<sup>2</sup> (156 ft<sup>2</sup>)**



ST

**8,8 kg (19.4 lb.)**

## +GF + Agie Charmilles



**H 34 1158/21**

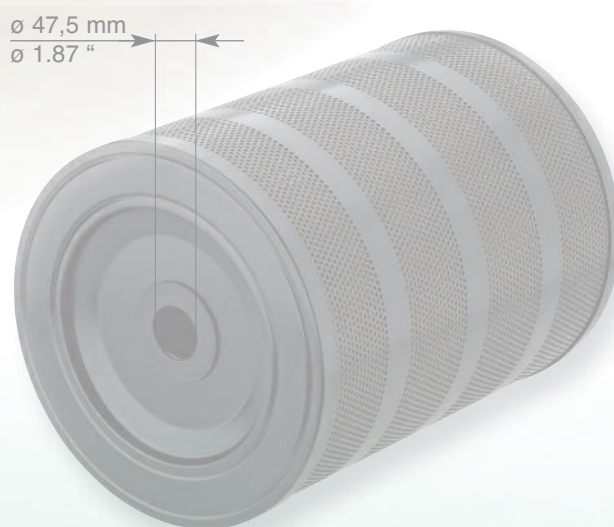

**3 - 5  $\mu\text{m}$**



**14,5 m<sup>2</sup> (156 ft<sup>2</sup>)**



**8,8 kg (19.4 lb.)**



## +GF + Agie Charmilles



**H 34 1790/2**

$\varnothing 47,5 \text{ mm}$   
 $\varnothing 1.87 \text{ ''}$

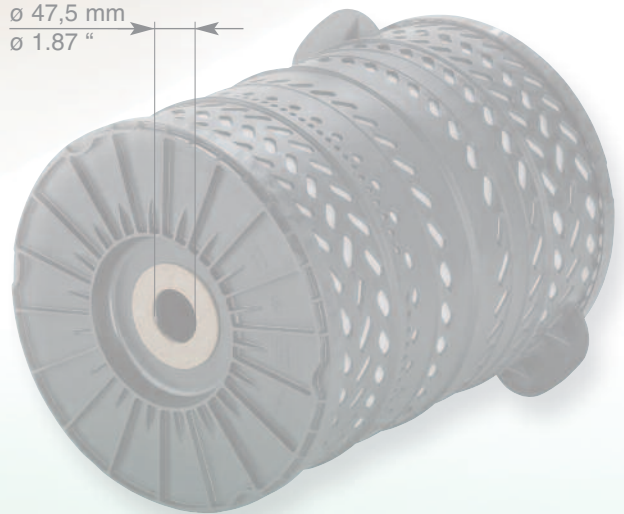

**3 - 5  $\mu\text{m}$**



**17,0  $\text{m}^2$  (183  $\text{ft}^2$ )**



**7,8  $\text{kg}$  (17.2  $\text{lb.}$ )**



## +GF + Agie Charmilles



**H 34 2090**

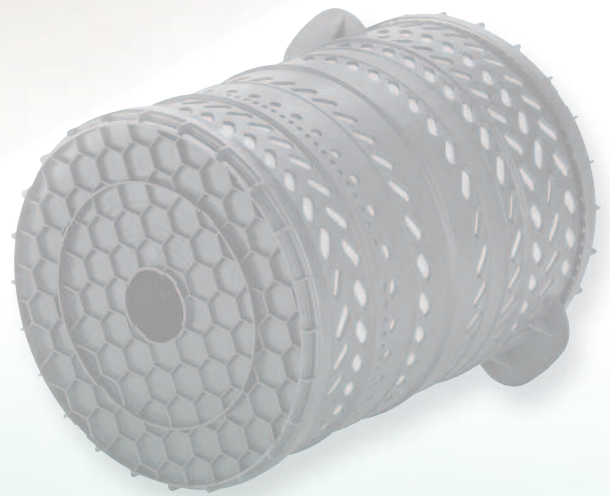

**3 - 5  $\mu\text{m}$**



**20,6 m<sup>2</sup> (222 ft<sup>2</sup>)**



**8,1 kg (17.9 lb.)**



## +GF + Agie Charmilles

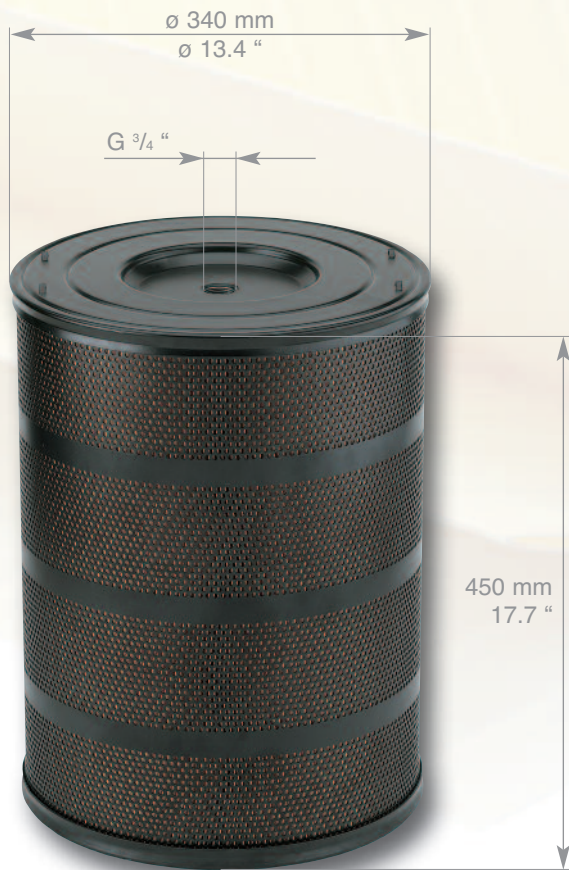

**H 34 2240**

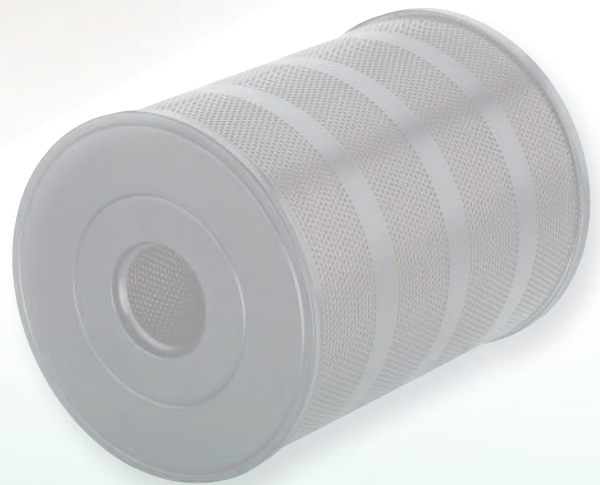

**3 - 5  $\mu\text{m}$**



**22,4 m<sup>2</sup> (241 ft<sup>2</sup>)**



**11,8 kg (26.0 lb.)**



## +GF + Agie Charmilles



**H 34 2240/20 Kit**

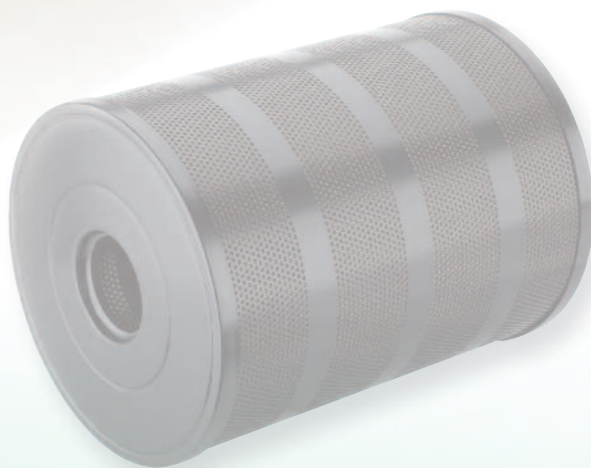

**3 - 5  $\mu\text{m}$**



**22,4 m<sup>2</sup> (241 ft<sup>2</sup>)**



**11,8 kg (26.0 lb.)**



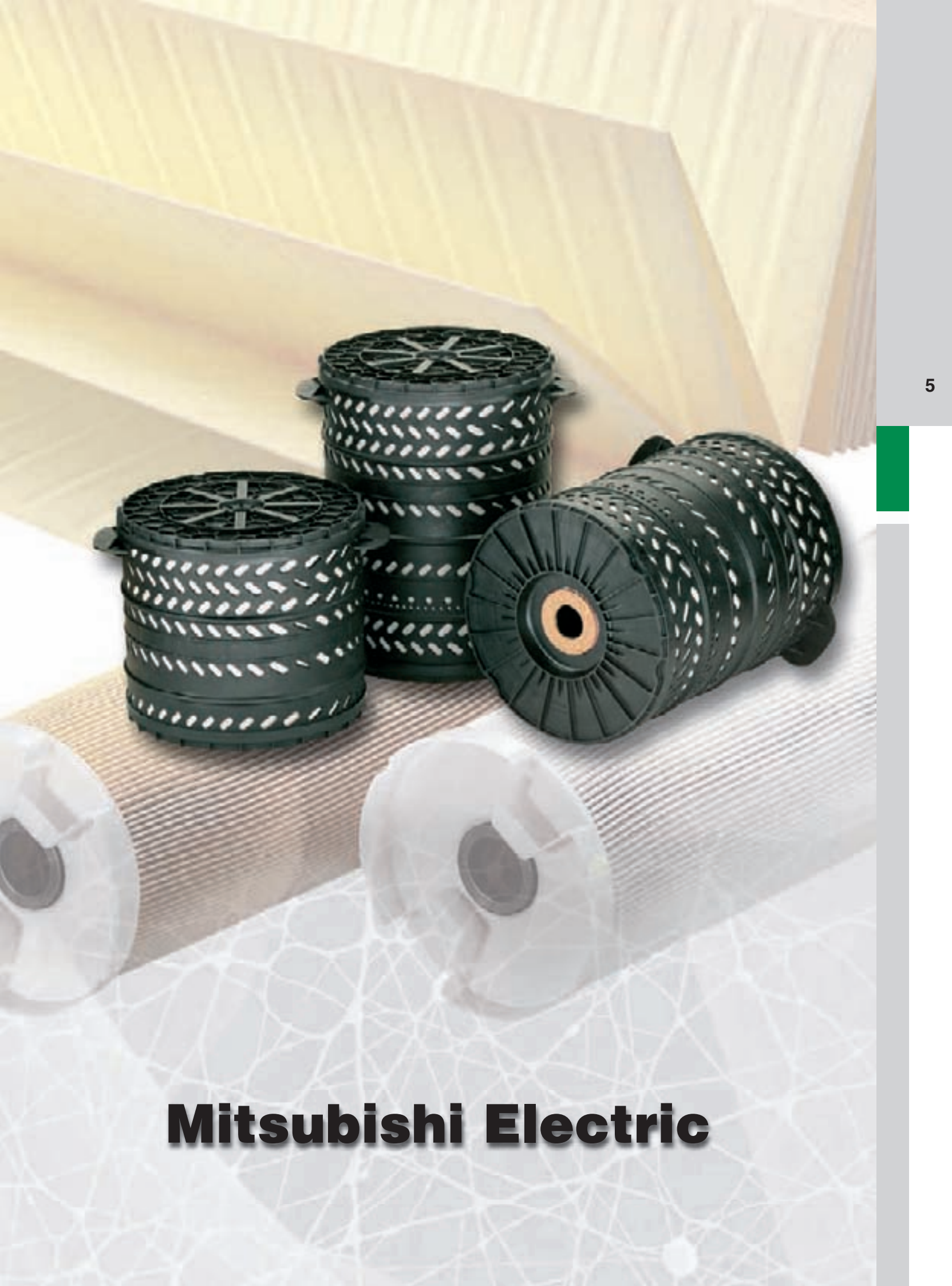

**Mitsubishi Electric**

# Mitsubishi Electric

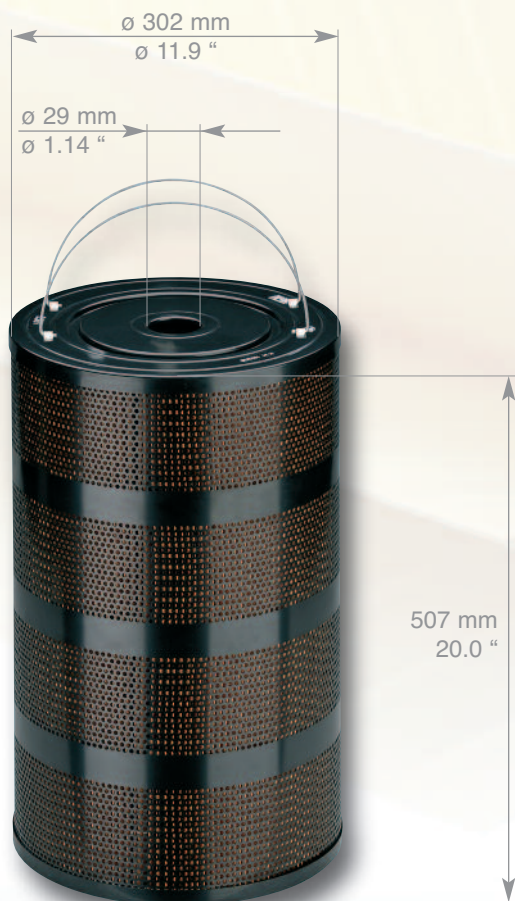

**H 31 967/20**

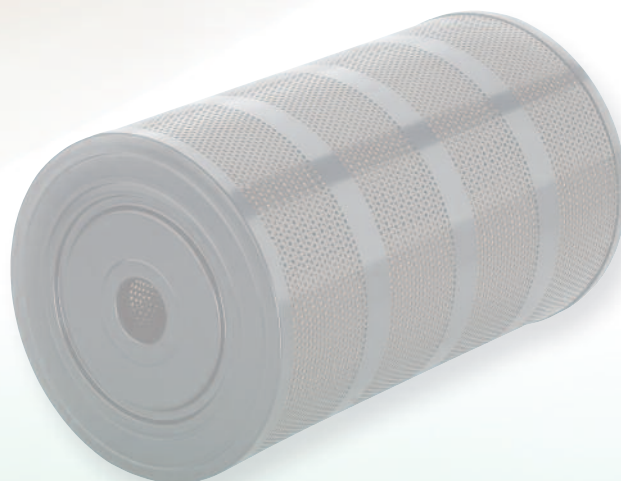

WEDM

**3 - 5  $\mu\text{m}$**

**9,5 m<sup>2</sup> (103 ft<sup>2</sup>)**



ST

**7,0 kg (15.4 lb.)**



# Mitsubishi Electric



**H 31 1033/20**

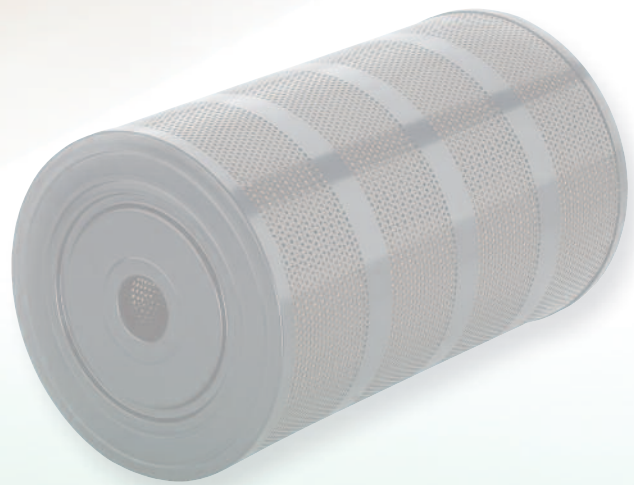

**3 - 5 µm**



**9,9 m<sup>2</sup> (107 ft<sup>2</sup>)**



**6,6 kg (14.6 lb.)**

# Mitsubishi Electric

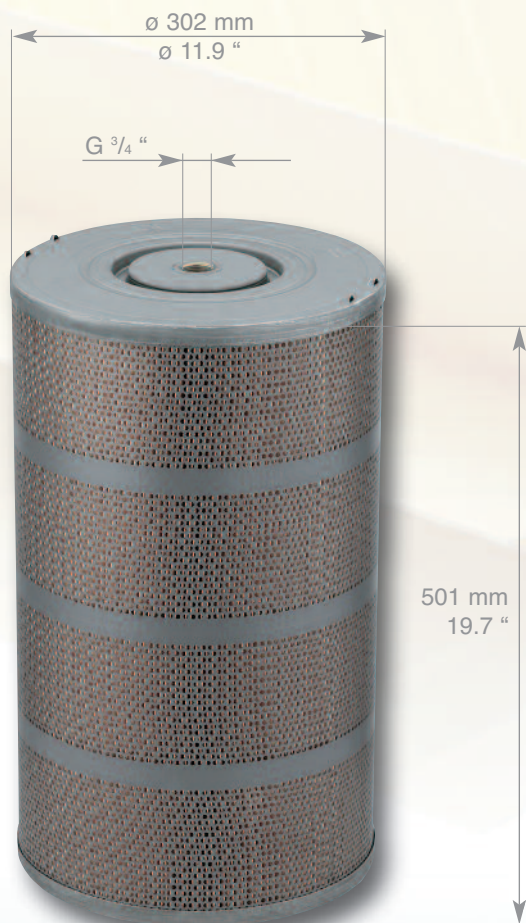

**H 31 1680**

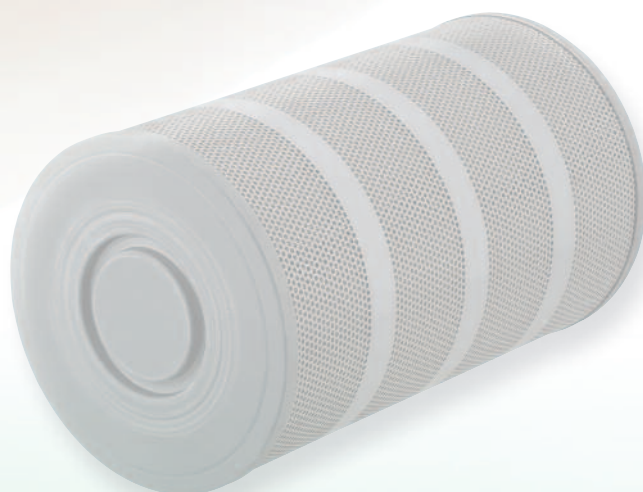

**3 - 5  $\mu\text{m}$**



**16,6 m<sup>2</sup> (179 ft<sup>2</sup>)**



**8,8 kg (19.4 lb.)**





# Mitsubishi Electric



**H 31 1680/1 Kit**

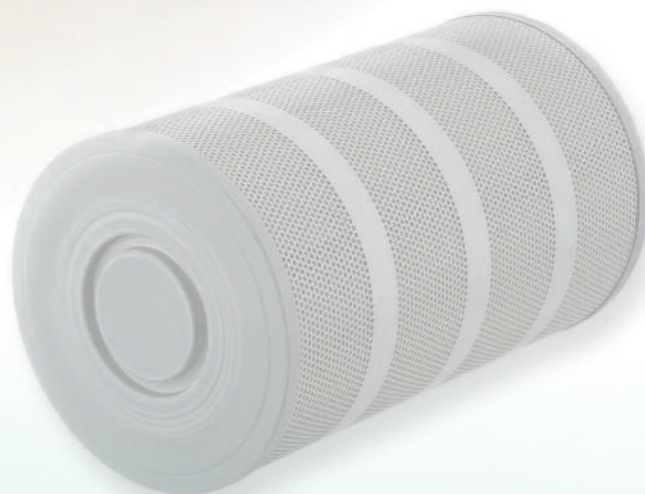

**3 - 5  $\mu\text{m}$**



**16,6 m<sup>2</sup> (179 ft<sup>2</sup>)**



**8,9 kg (19.6 lb.)**



# Mitsubishi Electric

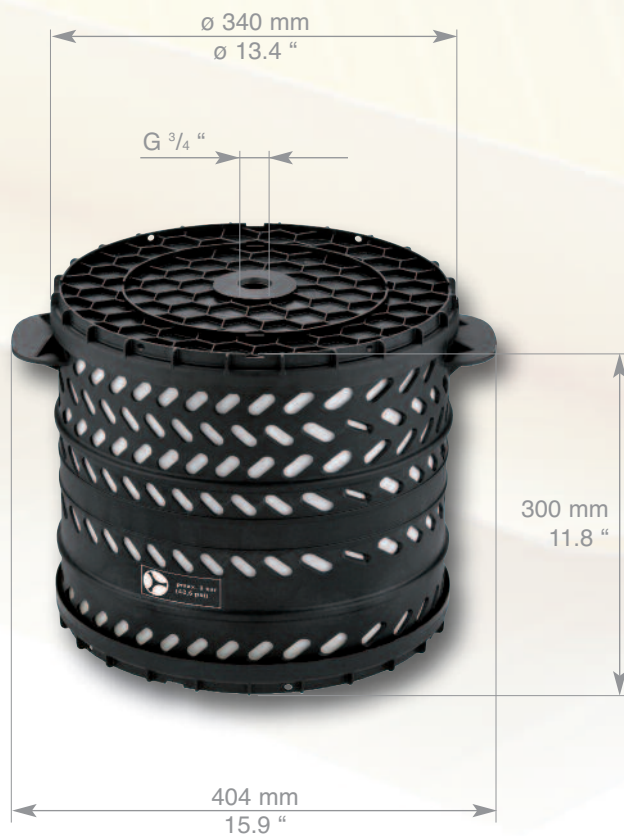

**H 34 1490/4 Kit**

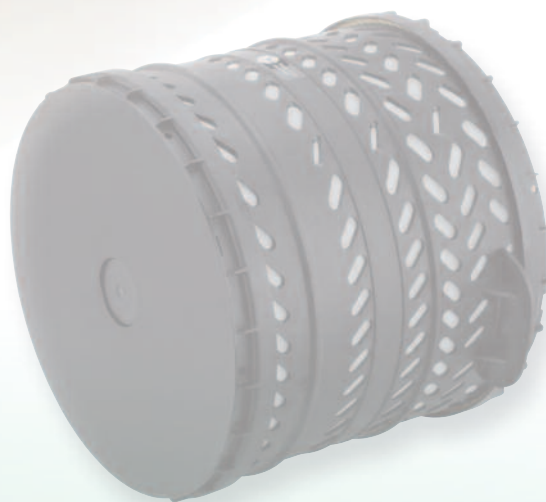

WEDM



**1 - 2  $\mu\text{m}$**



PL



**14,8 m<sup>2</sup> (159 ft<sup>2</sup>)**



**6,4 kg (14.1 lb.)**



inkl.



# Mitsubishi Electric

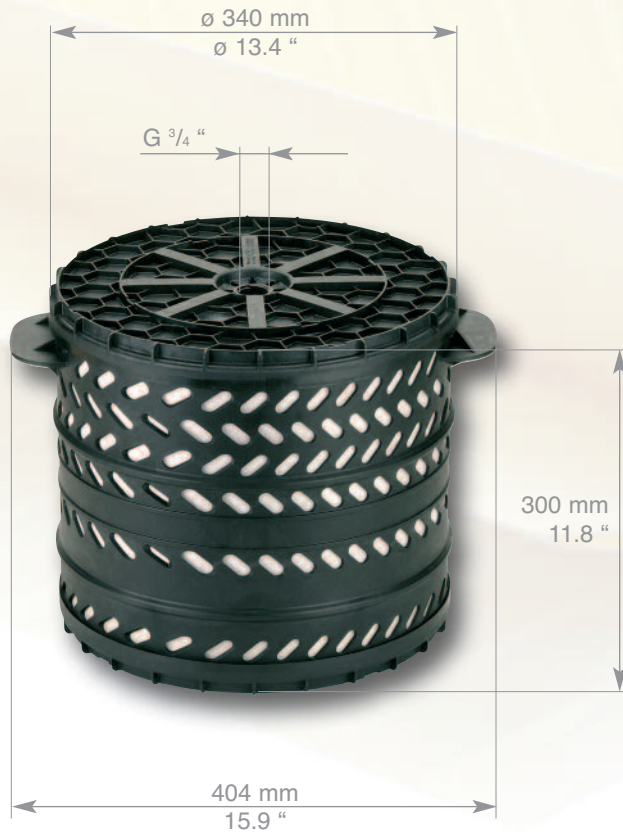

**H 34 1390/1**

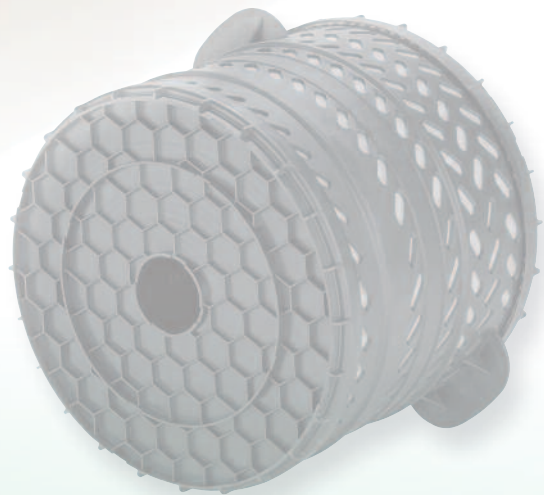

**1 - 2  $\mu\text{m}$**



**13,5 m<sup>2</sup> (145 ft<sup>2</sup>)**



**6,4 kg (14.1 lb.)**

# Mitsubishi Electric

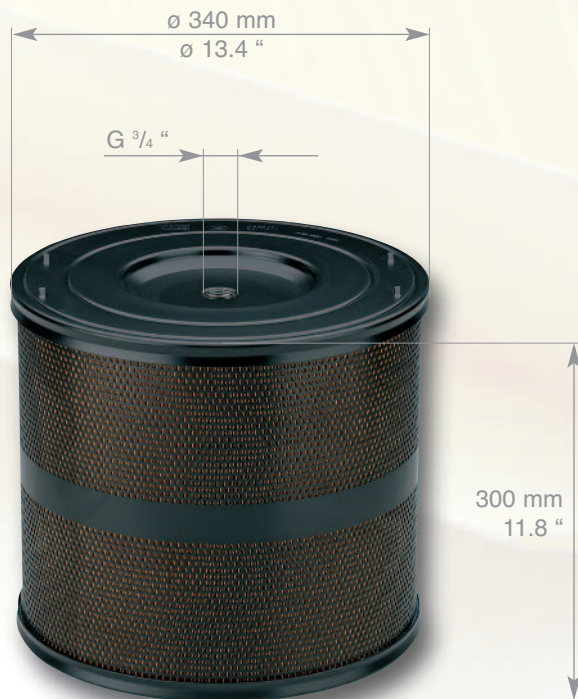

**H 34 1380/1**

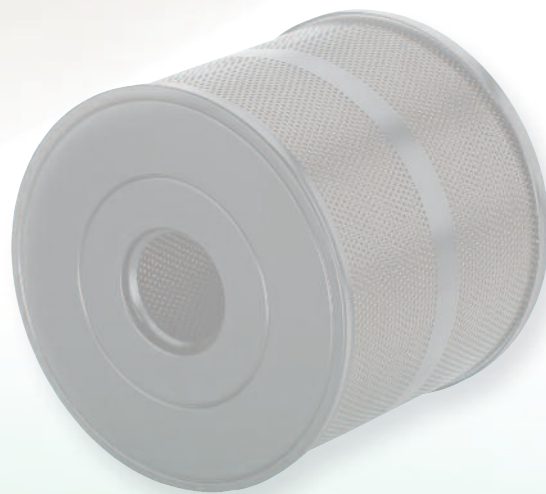

**1 - 2  $\mu\text{m}$**



**14,2 m<sup>2</sup> (153 ft<sup>2</sup>)**



**8,5 kg (18.7 lb.)**





# Mitsubishi Electric

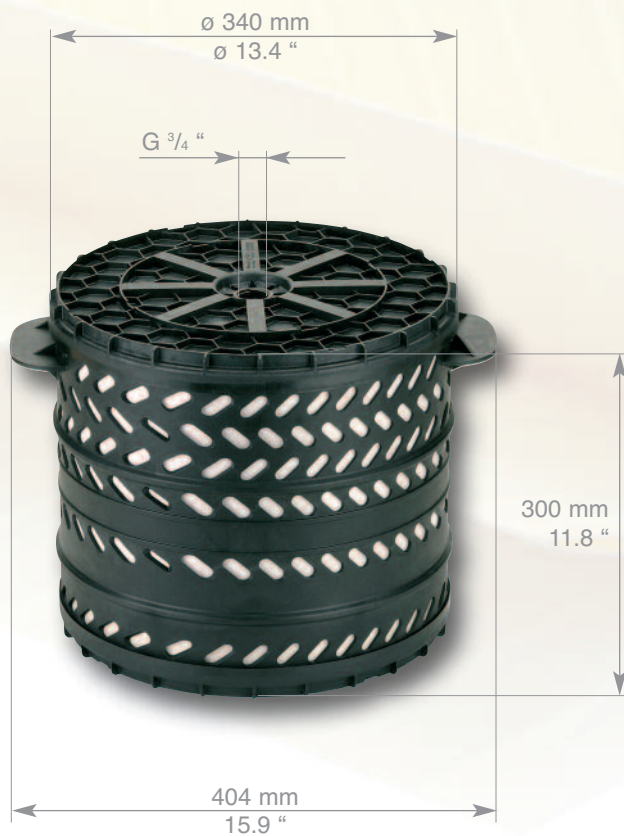

**H 34 1390**



WEDM



**3 - 5  $\mu\text{m}$**



PL



**13,5 m<sup>2</sup> (145 ft<sup>2</sup>)**



**6,4 kg (14.1 lb.)**



inkl.

# Mitsubishi Electric

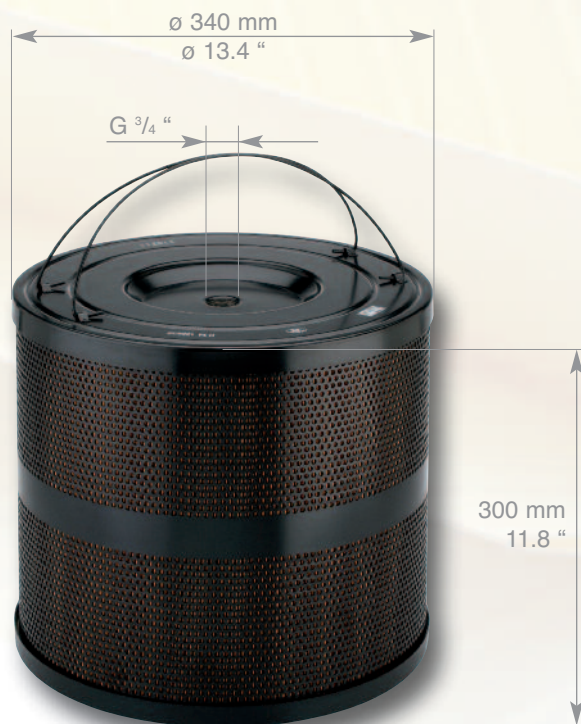

**H 34 1380/20 Kit**

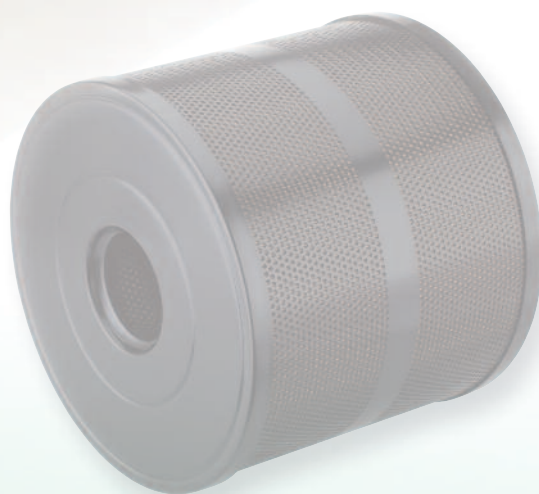

**3 - 5  $\mu\text{m}$**



**14,2 m<sup>2</sup> (153 ft<sup>2</sup>)**



**inkl.**



**8,5 kg (18.7 lb.)**



# Mitsubishi Electric

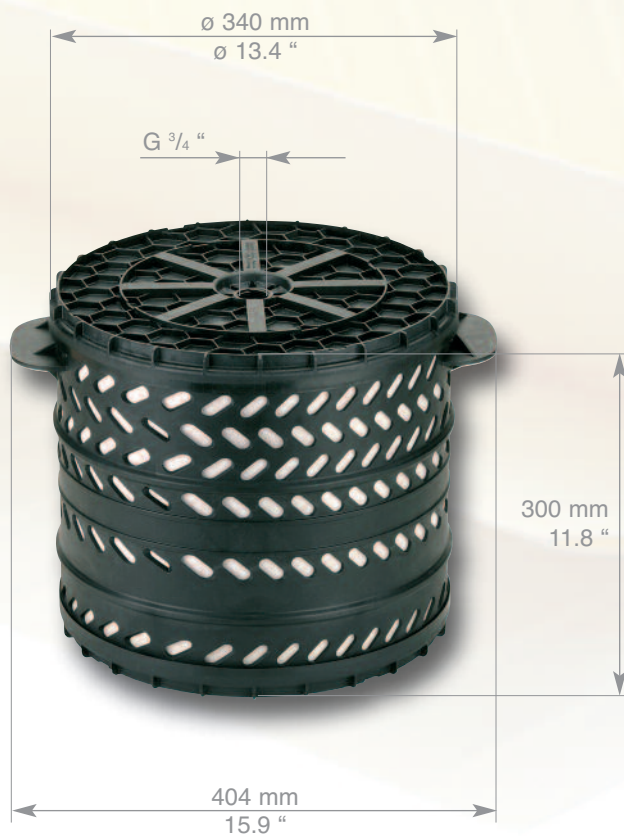

**H 34 1390/2**

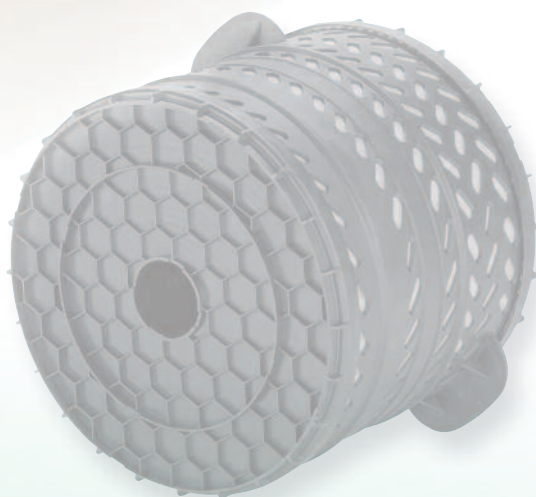

**10  $\mu\text{m}$**



**12,8 m<sup>2</sup> (138 ft<sup>2</sup>)**



**5,7 kg (12.6 lb.)**

# Mitsubishi Electric

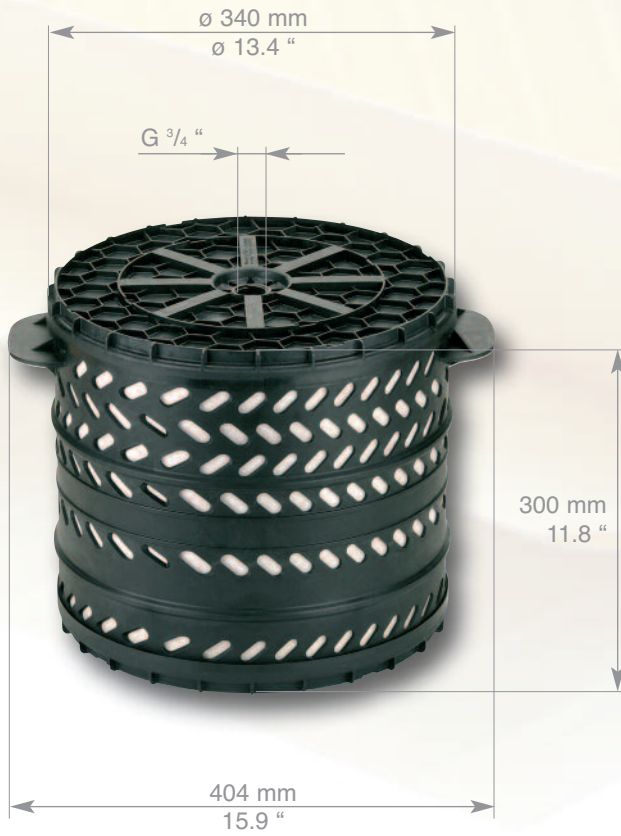

**H 34 1390/3**

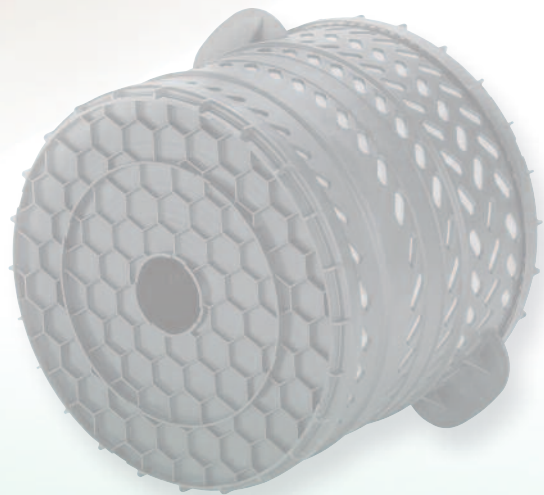

**25  $\mu\text{m}$**



**10,2 m<sup>2</sup> (110 ft<sup>2</sup>)**



**5,7 kg (12.6 lb.)**



# Mitsubishi Electric



**H 34 2090 Kit**

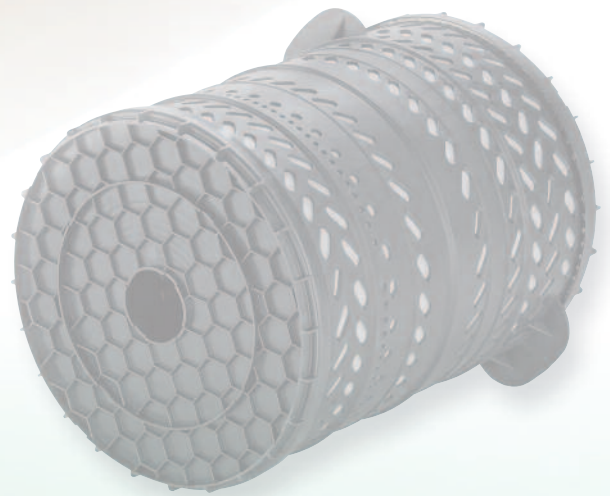

**3 - 5  $\mu\text{m}$**



**20,6 m<sup>2</sup> (222 ft<sup>2</sup>)**



**8,1 kg (17.9 lb.)**

# Mitsubishi Electric

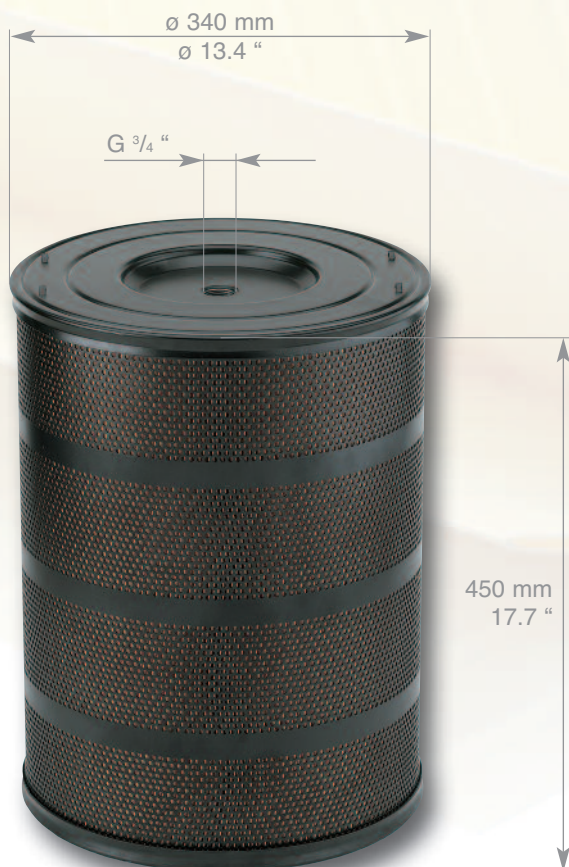

**H 34 2240**

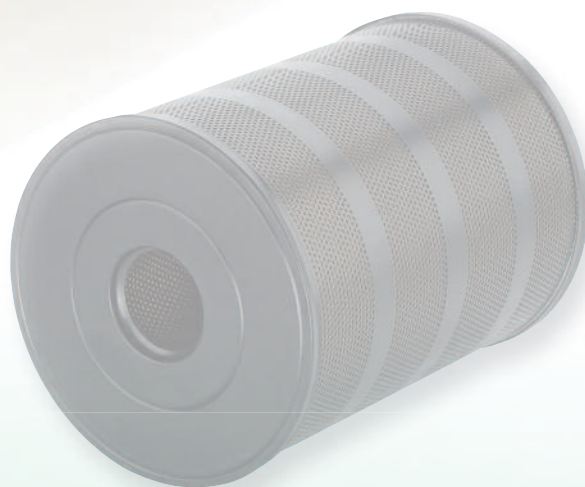

**3 - 5  $\mu\text{m}$**



**22,4 m<sup>2</sup> (241 ft<sup>2</sup>)**



**11,8 kg (26.0 lb.)**





# Mitsubishi Electric



**H 34 2240/20 Kit**

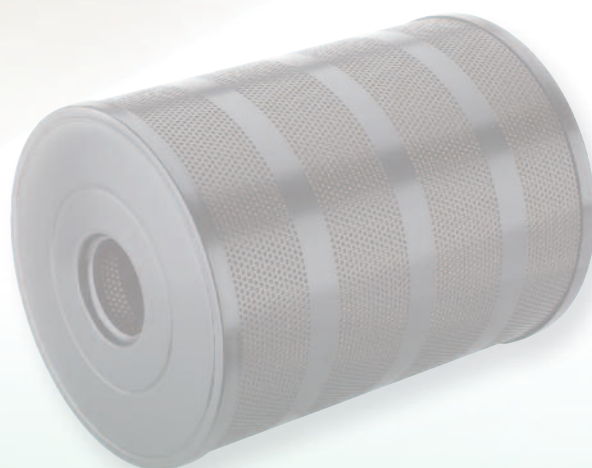

**3 - 5 µm**



**22,4 m<sup>2</sup> (241 ft<sup>2</sup>)**



**11,8 kg (26.0 lb.)**



**Makino**



# Makino

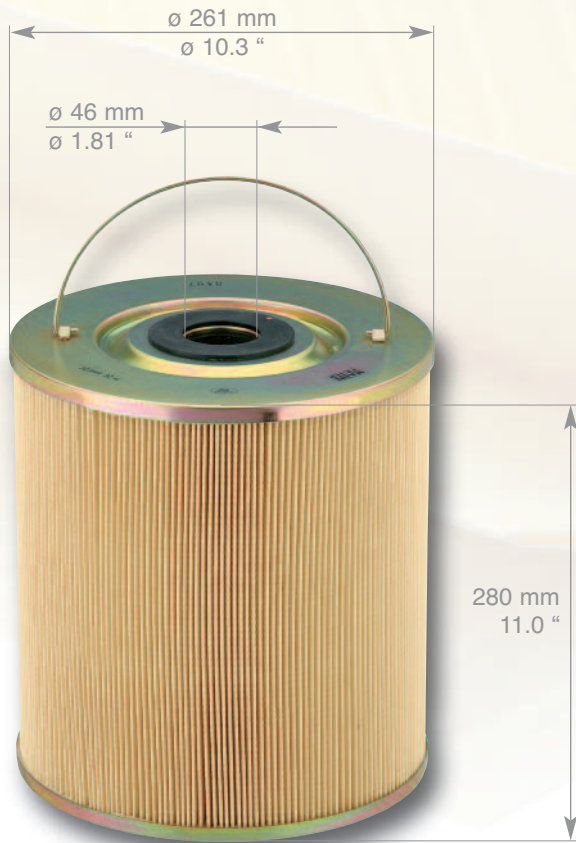

**H 26 644/20**



EDM



ST



**3 - 5  $\mu\text{m}$**



**5,4 m<sup>2</sup> (58 ft<sup>2</sup>)**



**3,7 kg (8.1 lb.)**

# Makino

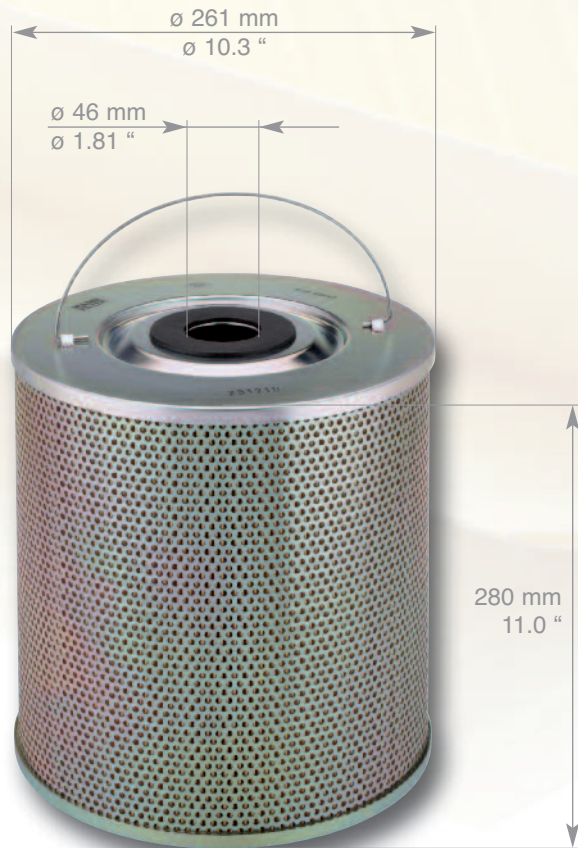

**H 26 644/21**



**EDM**

**3 - 5  $\mu\text{m}$**

**5,4 m<sup>2</sup> (58 ft<sup>2</sup>)**



**↓**

**ST**

**KG**

**4,5 kg (8.8 lb.)**



# Makino



**H 31 967/20**

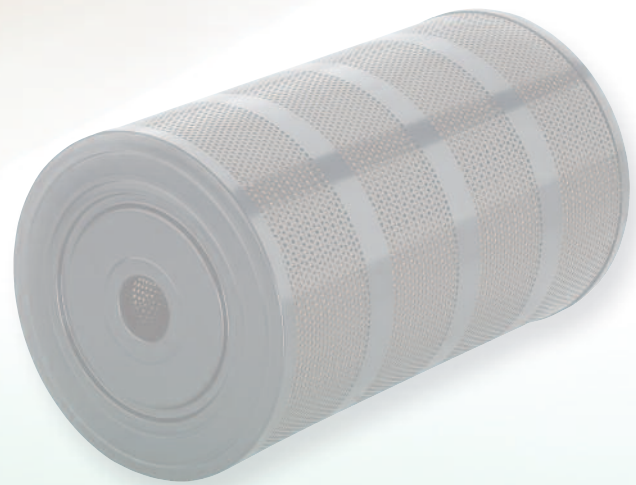

**3 - 5  $\mu\text{m}$**

**9,5 m<sup>2</sup> (103 ft<sup>2</sup>)**



**7,0 kg (15.4 lb.)**

# Makino



**H 31 1033/20**

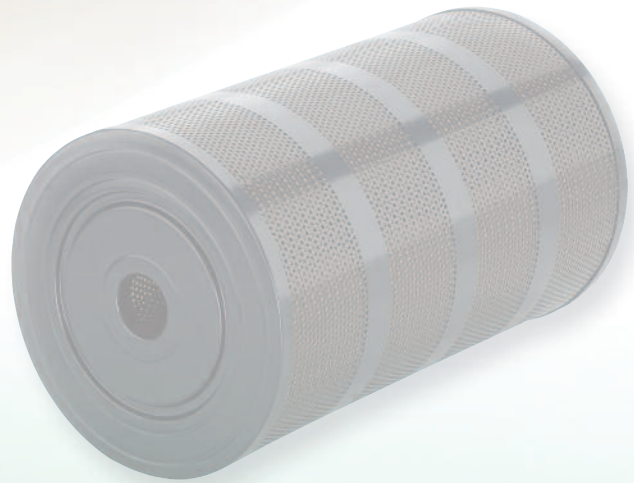

**3 - 5 µm**



**9,9 m<sup>2</sup> (107 ft<sup>2</sup>)**



**6,6 kg (14.6 lb.)**



# Makino

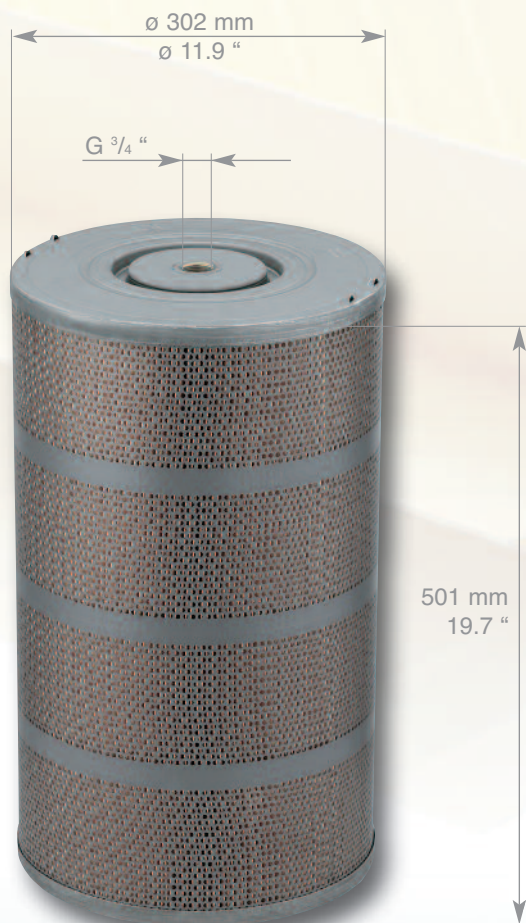

**H 31 1680**

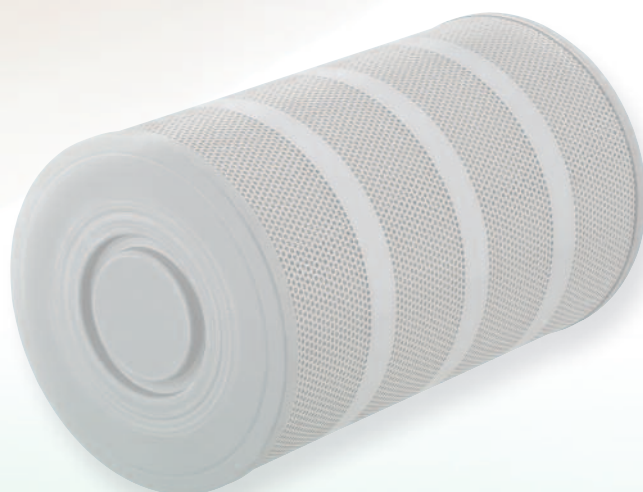

**3 - 5  $\mu\text{m}$**



**16,6 m<sup>2</sup> (179 ft<sup>2</sup>)**



**8,8 kg (19.4 lb.)**



# Makino



**H 31 1680/1 Kit**

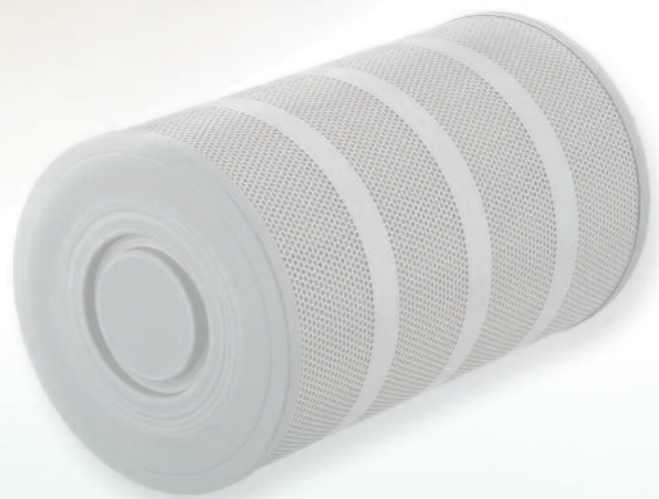

**3 - 5  $\mu\text{m}$**



**16,6 m<sup>2</sup> (179 ft<sup>2</sup>)**



**inkl.**



**8,9 kg (19.6 lb.)**





# Makino

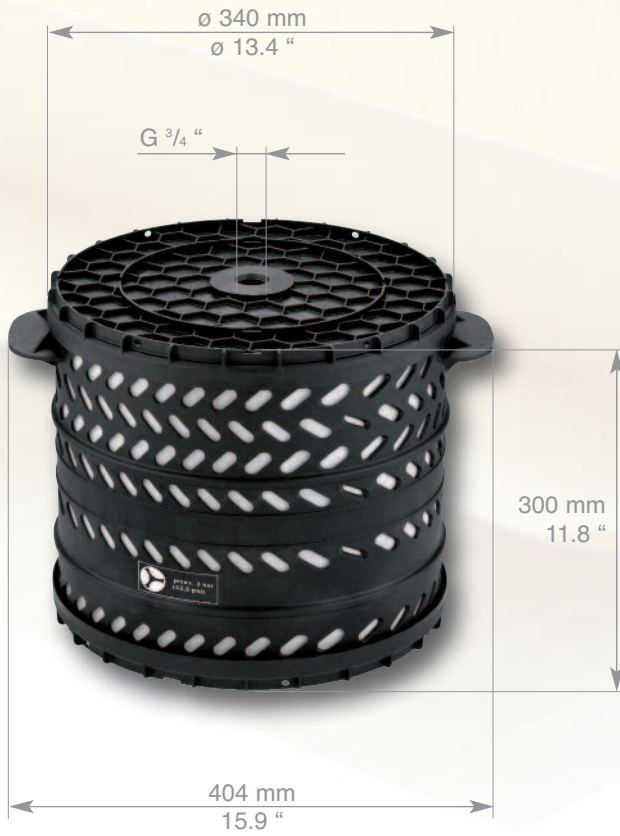

**H 34 1490/4 Kit**

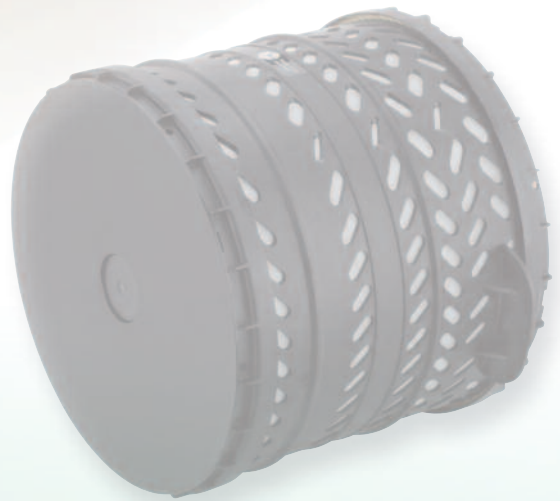

**1 - 2  $\mu\text{m}$**



**14,8 m<sup>2</sup> (159 ft<sup>2</sup>)**



**6,4 kg (14.1 lb.)**

# Makino

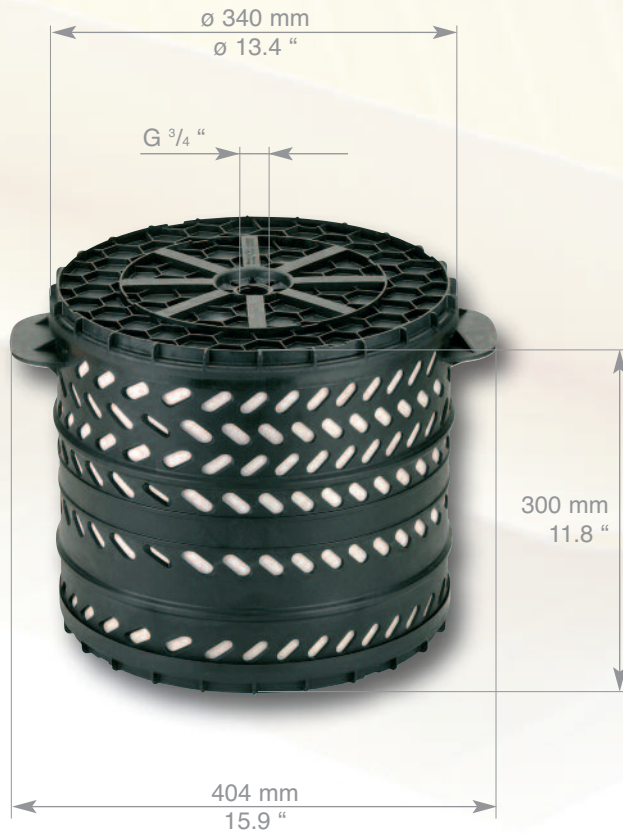

**H 34 1390/1**

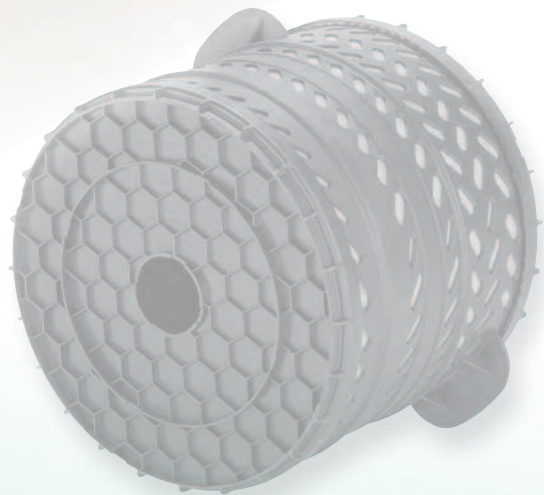

**1 - 2 µm**



**13,5 m<sup>2</sup> (145 ft<sup>2</sup>)**



**6,4 kg (14.1 lb.)**



# Makino

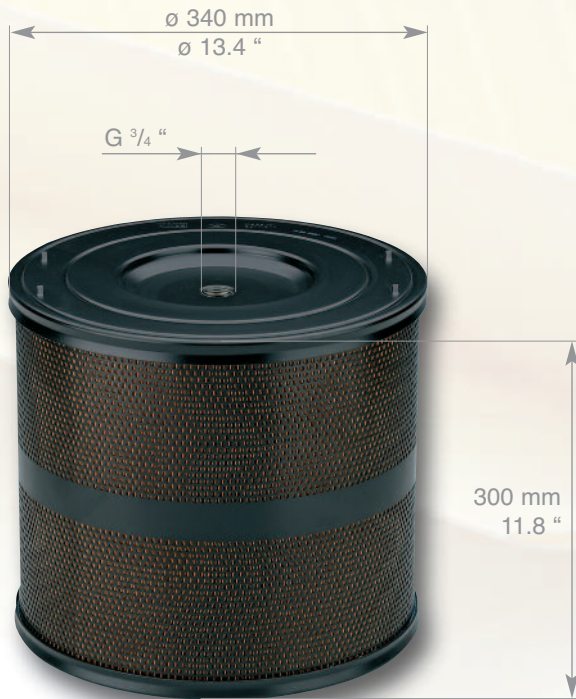

**H 34 1380/1**

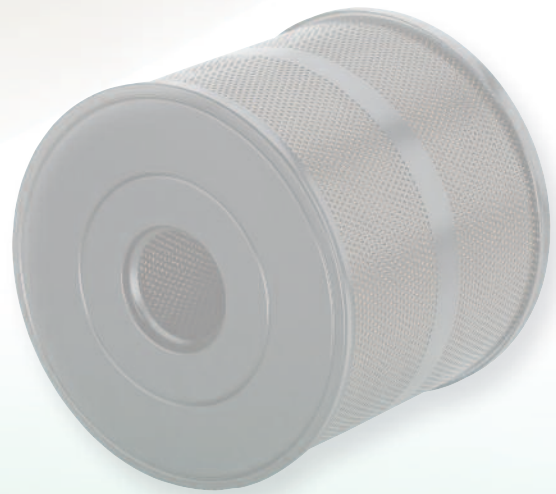

**1 - 2  $\mu\text{m}$**



**14,2 m<sup>2</sup> (153 ft<sup>2</sup>)**



**8,5 kg (18.7 lb.)**



# Makino

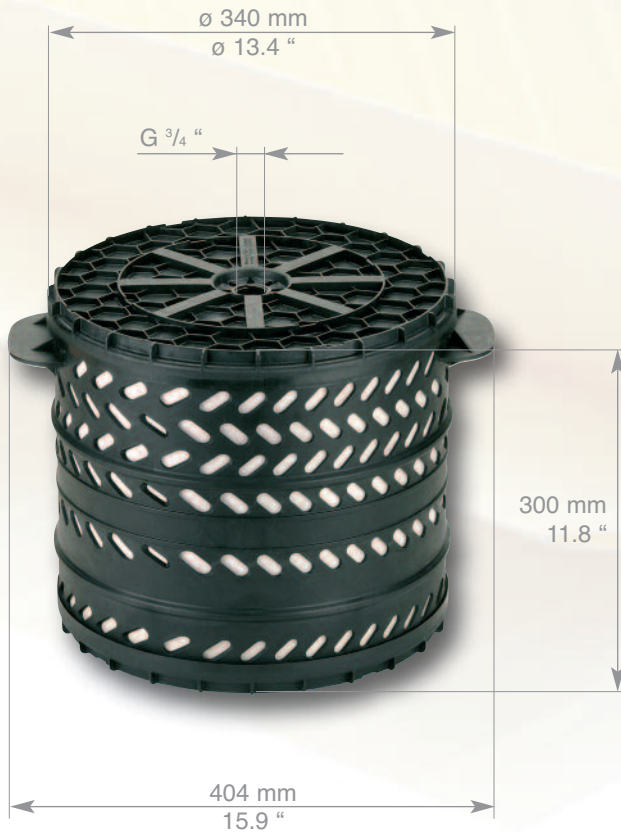

**H 34 1390**



**3 - 5  $\mu\text{m}$**



**13,5 m<sup>2</sup> (145 ft<sup>2</sup>)**



**6,4 kg (14.1 lb.)**



# Makino

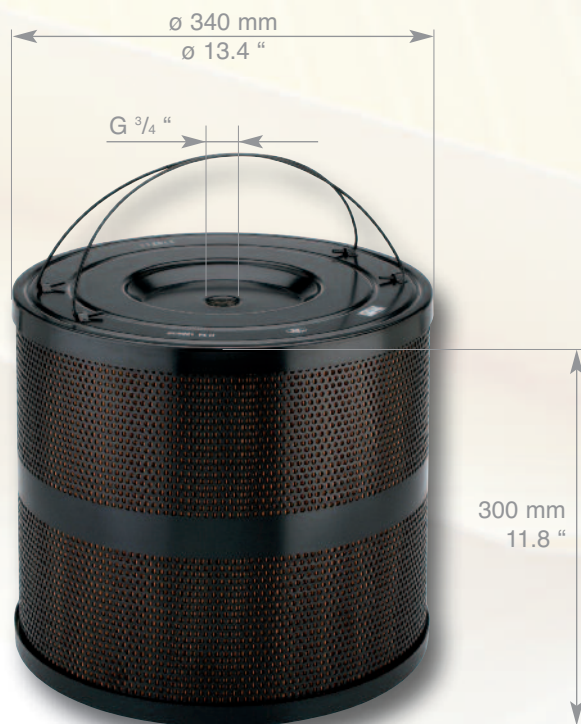

**H 34 1380/20 Kit**

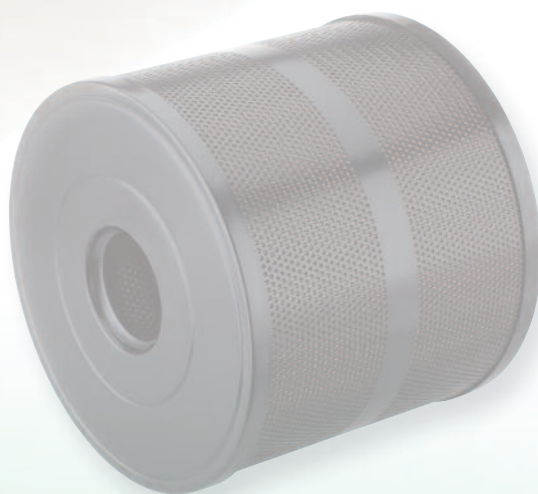

**3 - 5  $\mu$ m**



**14,2 m<sup>2</sup> (153 ft<sup>2</sup>)**



**8,5 kg (18.7 lb.)**

# Makino

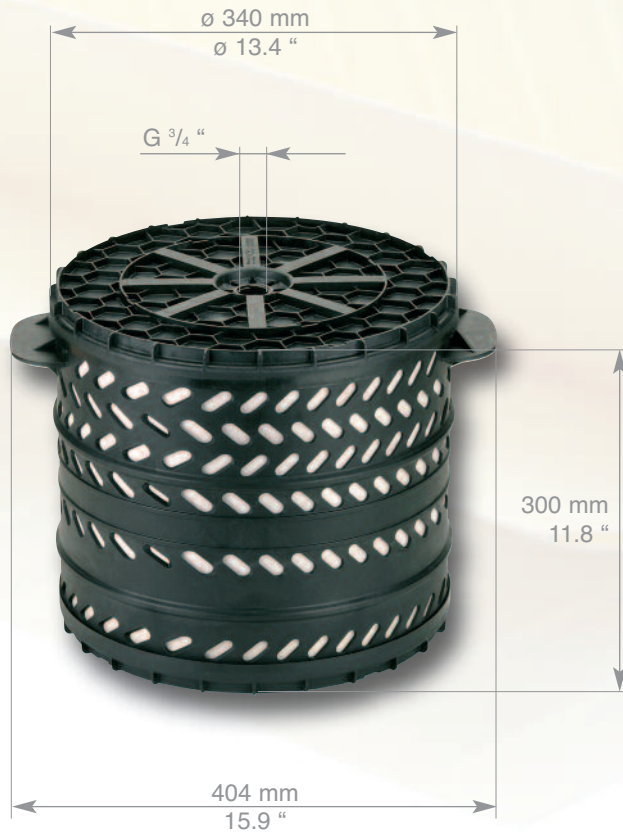

**H 34 1390/2**

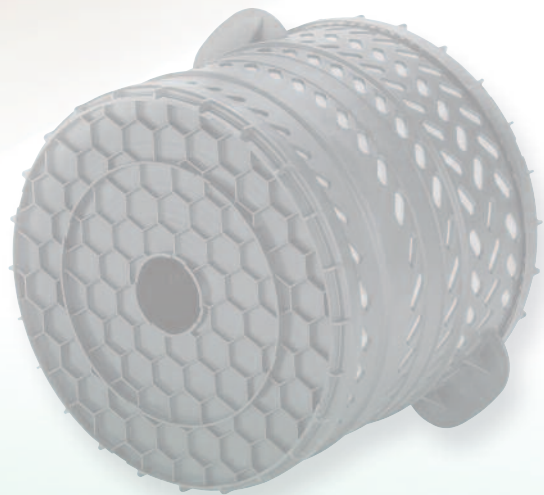

**10  $\mu\text{m}$**



**12,8 m<sup>2</sup> (138 ft<sup>2</sup>)**



**5,7 kg (12.6 lb.)**



# Makino

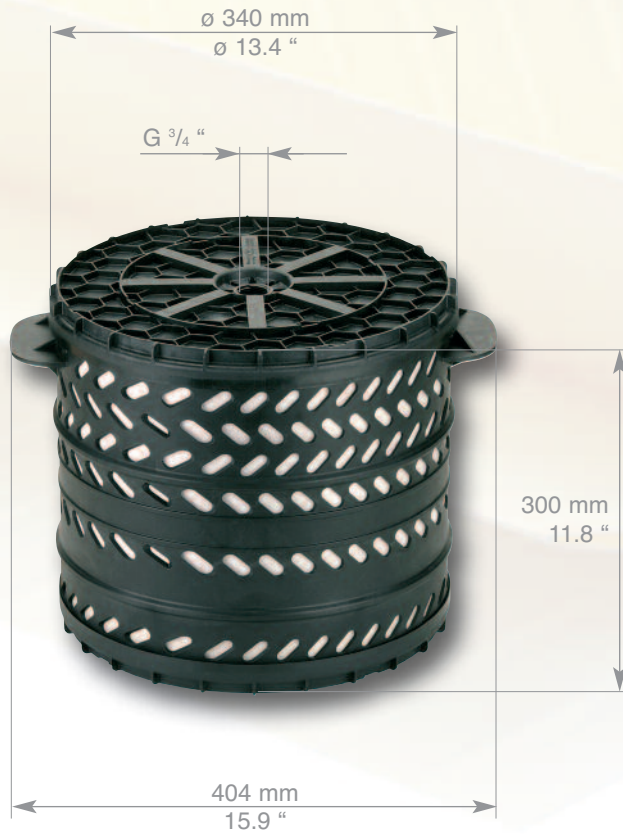

**H 34 1390/3**

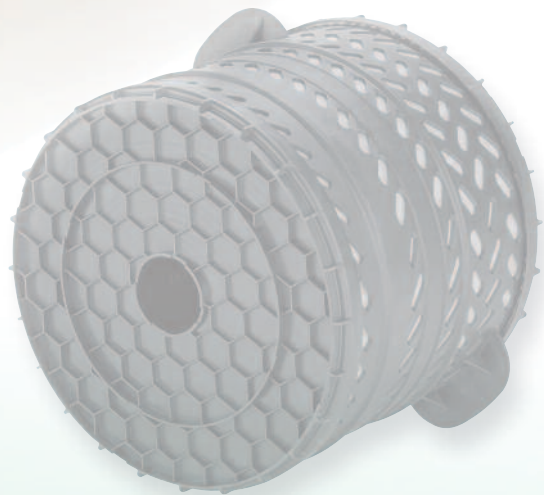

**25 µm**



**10,2 m<sup>2</sup> (110 ft<sup>2</sup>)**



**5,7 kg (12.6 lb.)**



**Fanuc**



# Fanuc

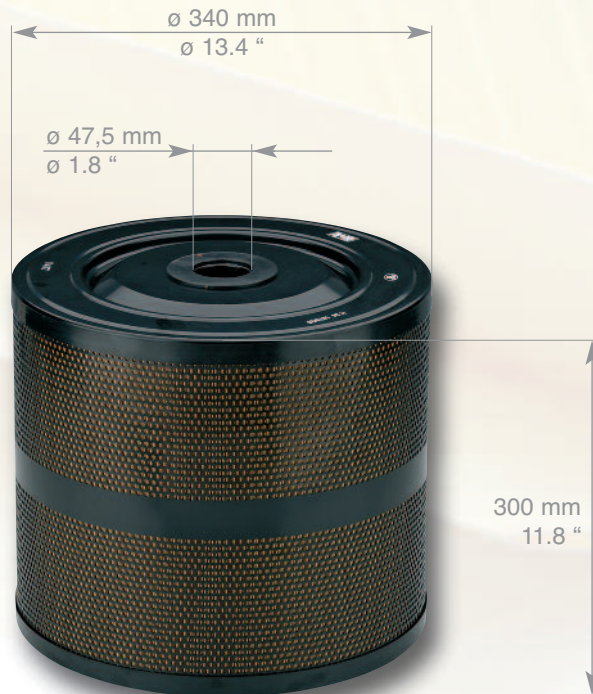

**H 34 1070/1**



WEDM



**1 - 2  $\mu\text{m}$**



ST



**9,2 m<sup>2</sup> (99 ft<sup>2</sup>)**



**6,5 kg (13.2 lb.)**

# Fanuc

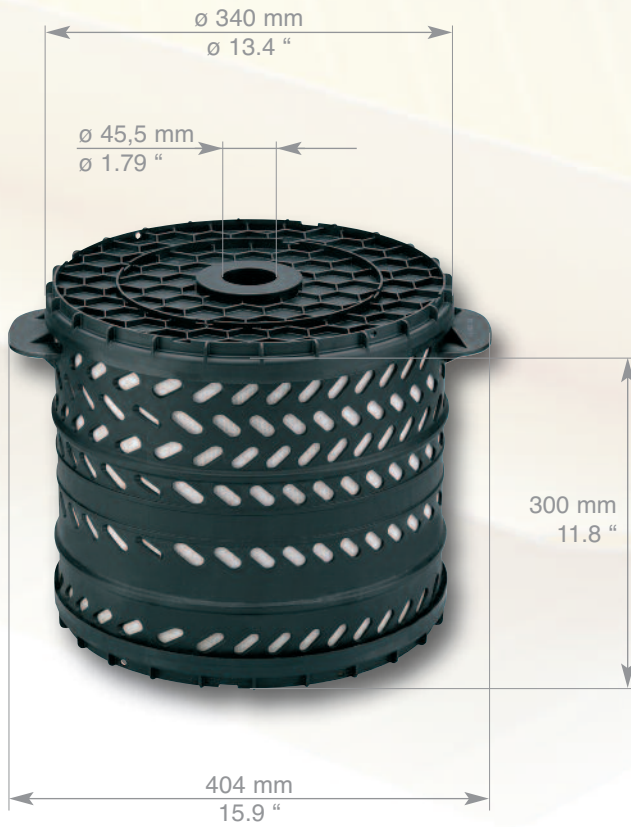

**H 34 1290/3**



**3 - 5  $\mu\text{m}$**



**10,5 m<sup>2</sup> (113 ft<sup>2</sup>)**



**6,2 kg (13.7 lb.)**



# Fanuc

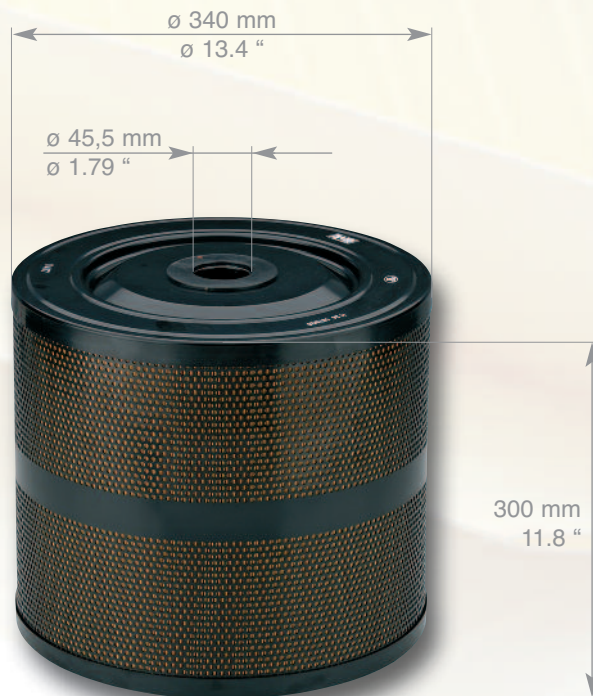

**H 34 1070/20**



WEDM



**3 - 5  $\mu\text{m}$**



ST



**10,7 m<sup>2</sup> (115 ft<sup>2</sup>)**



**6,4 kg (14.1 lb.)**

# Fanuc

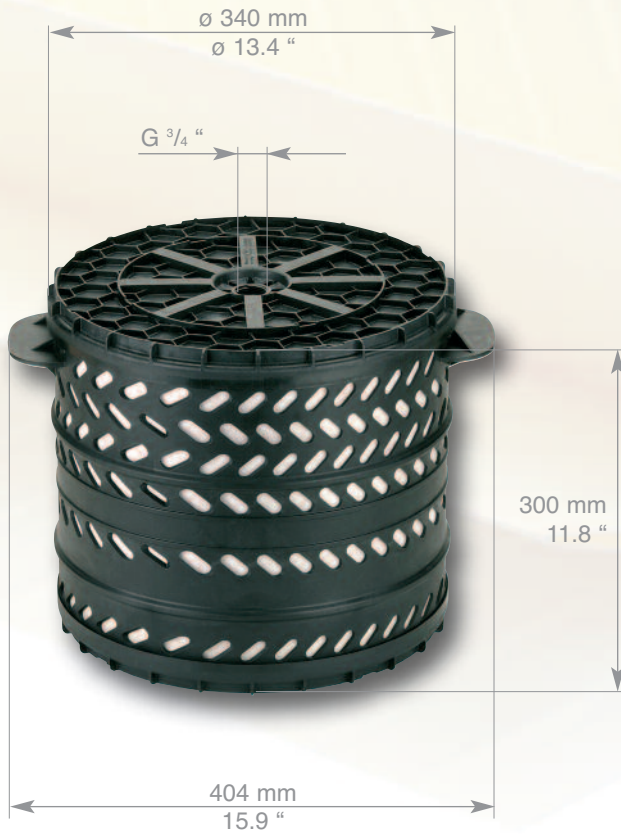

**H 34 1390/1**

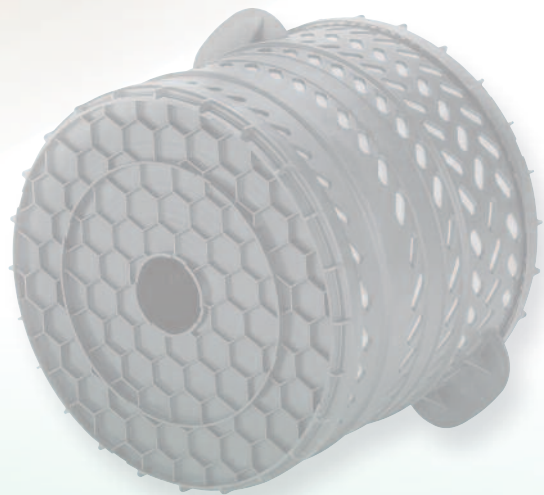

**1 - 2  $\mu\text{m}$**



**13,5 m<sup>2</sup> (145 ft<sup>2</sup>)**



**6,4 kg (14.1 lb.)**



# Fanuc

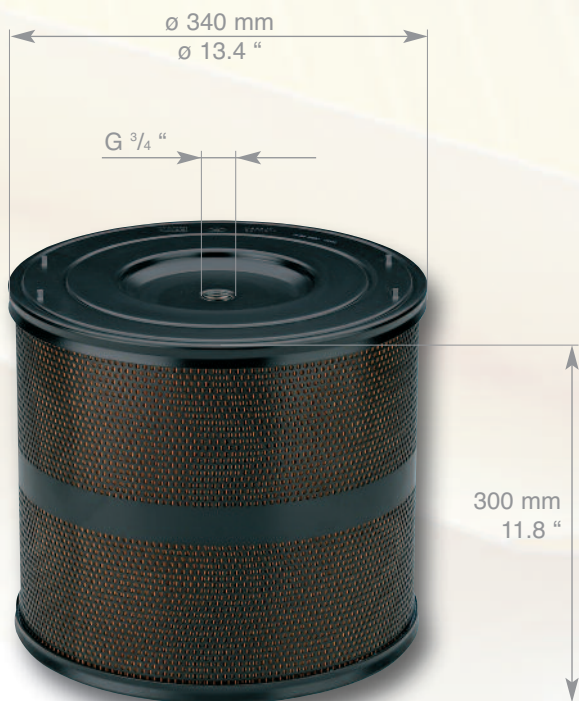

**H 34 1380/1**

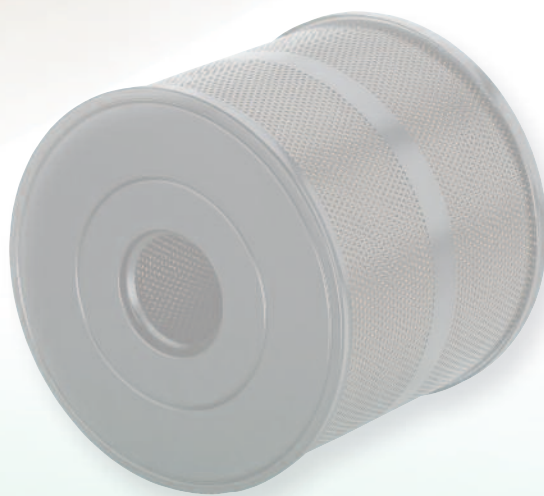

**1 - 2  $\mu\text{m}$**



**14,2 m<sup>2</sup> (153 ft<sup>2</sup>)**



**8,5 kg (18.7 lb.)**



# Fanuc

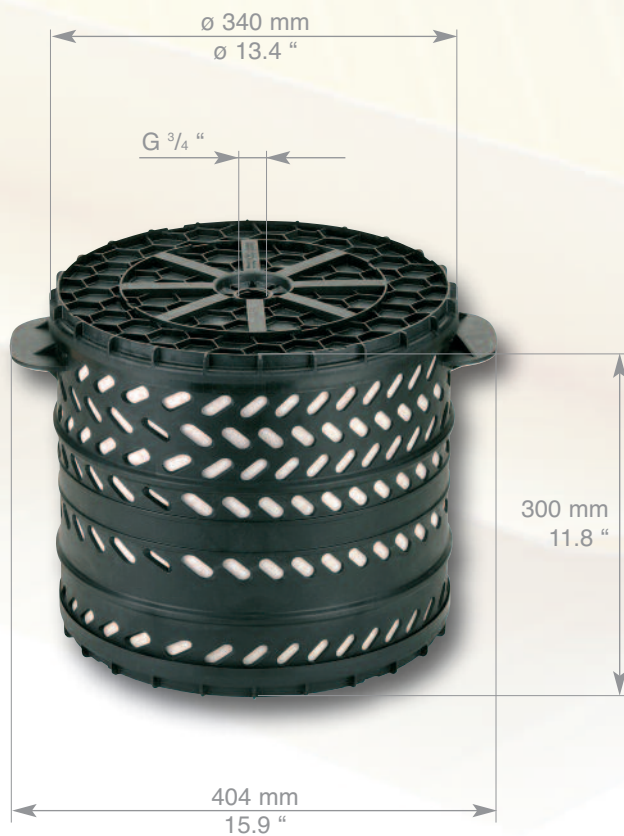

**H 34 1390**

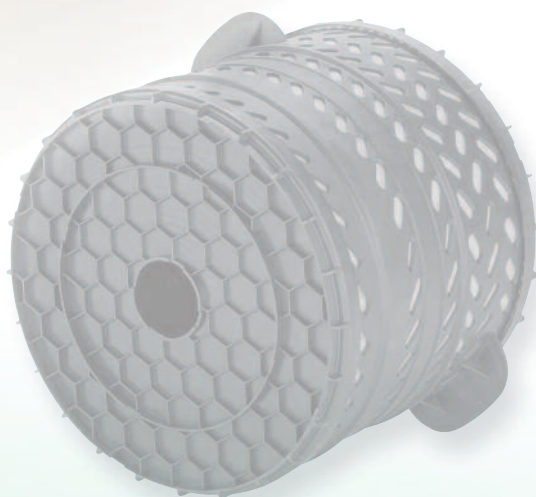

**3 - 5  $\mu\text{m}$**



**13,5 m<sup>2</sup> (145 ft<sup>2</sup>)**



**6,4 kg (14.1 lb.)**



# Fanuc

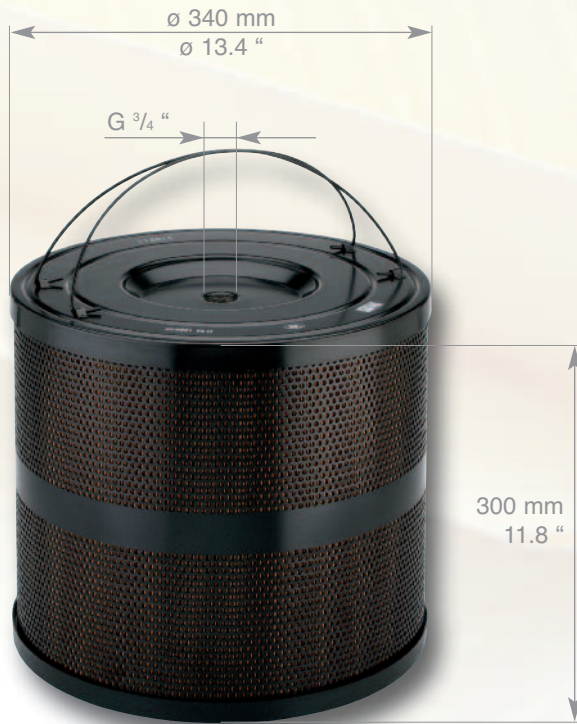

**H 34 1380/20 Kit**



**3 - 5  $\mu$ m**



**14,2 m<sup>2</sup> (153 ft<sup>2</sup>)**



**8,5 kg (18.7 lb.)**

# Fanuc

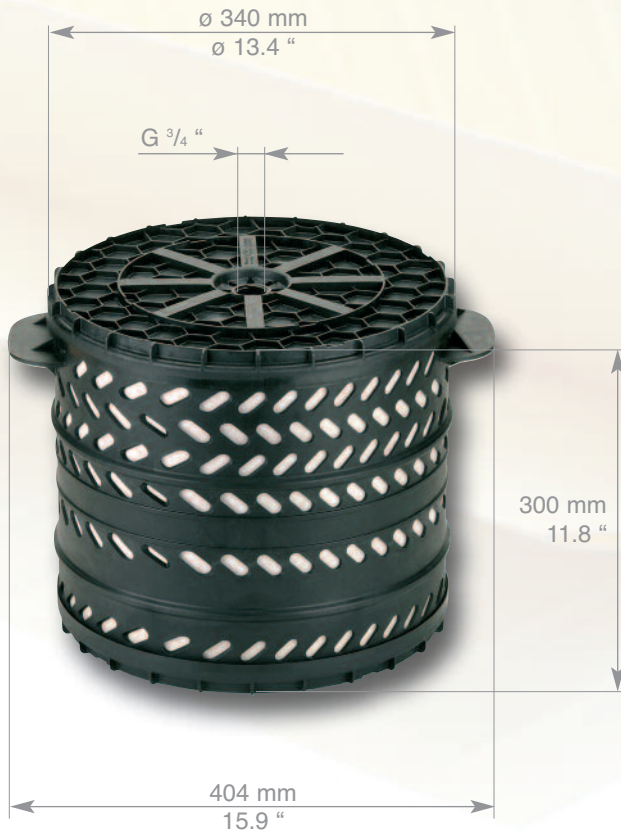

**H 34 1390/2**

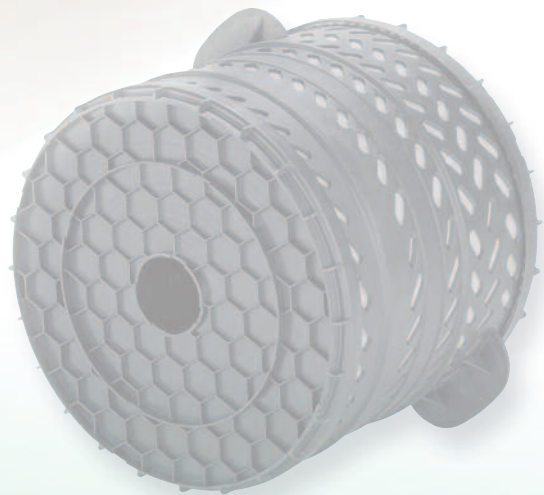

**10  $\mu\text{m}$**



**12,8 m<sup>2</sup> (138 ft<sup>2</sup>)**



**5,7 kg (12.6 lb.)**



# Fanuc

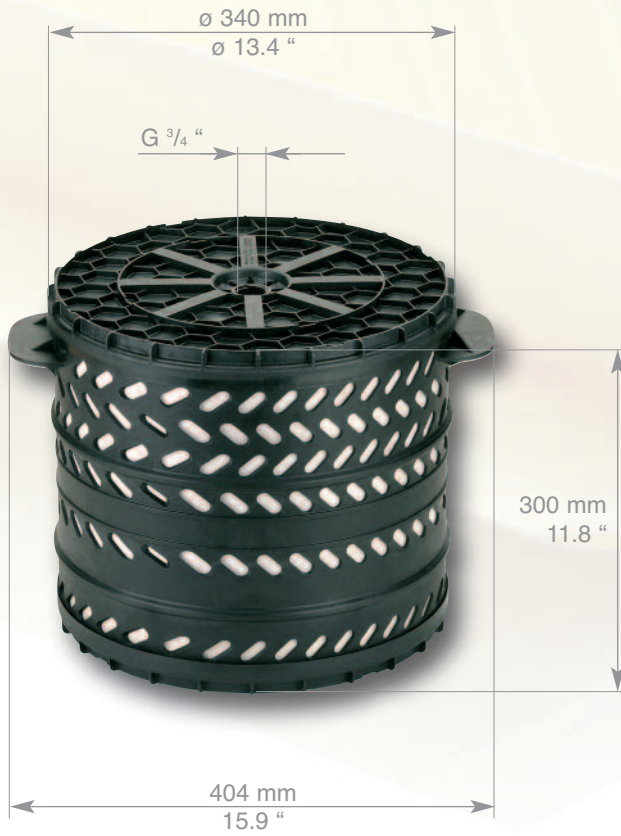

**H 34 1390/3**

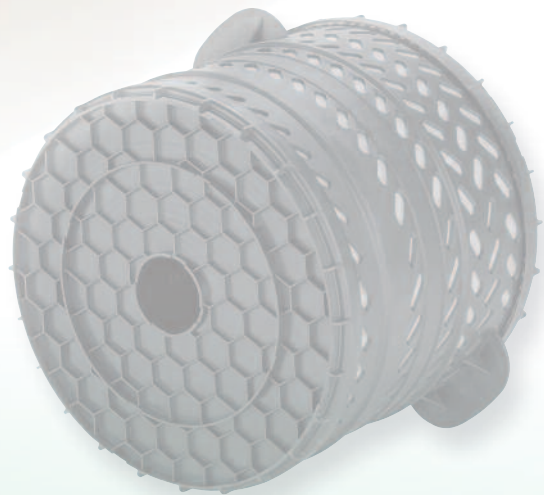

**25  $\mu\text{m}$**



**10,2 m<sup>2</sup> (110 ft<sup>2</sup>)**



**5,7 kg (12.6 lb.)**

# Fanuc

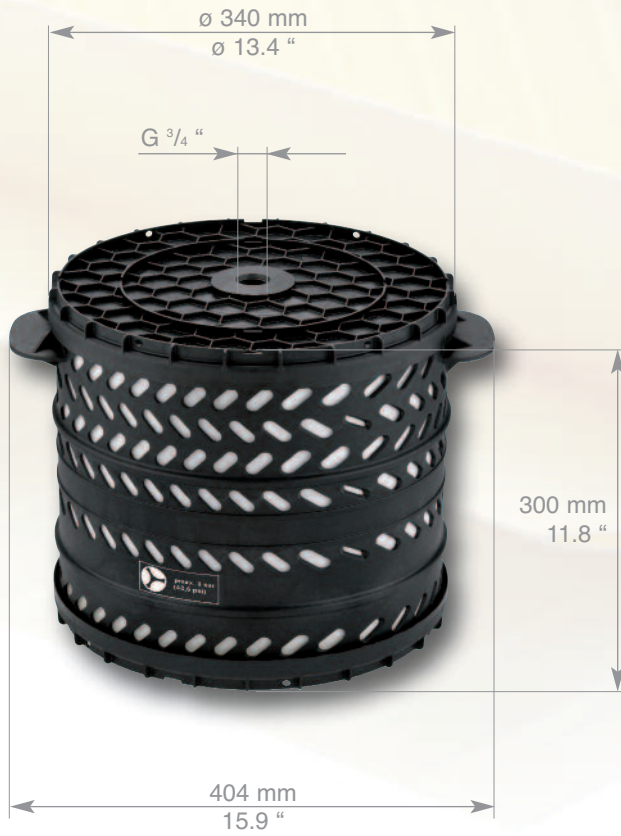

**H 34 1490/4 Kit**

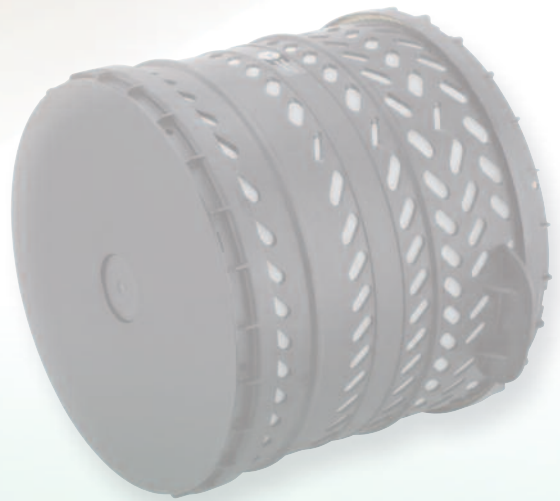

**1 - 2  $\mu\text{m}$**



**14,8 m<sup>2</sup> (159 ft<sup>2</sup>)**



**6,4 kg (14.1 lb.)**



# Fanuc



**H 34 1790/3**

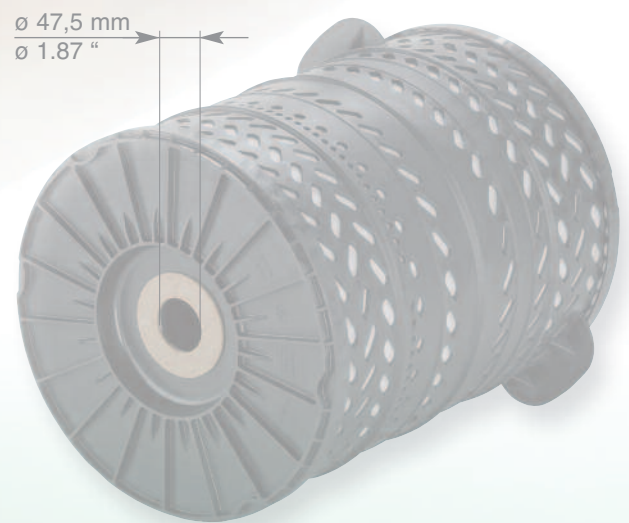

**3 - 5  $\mu\text{m}$**



**14,5 m<sup>2</sup> (156 ft<sup>2</sup>)**



**PL**



**6,6 kg (14.6 lb.)**



# Fanuc



**H 34 1158/20**

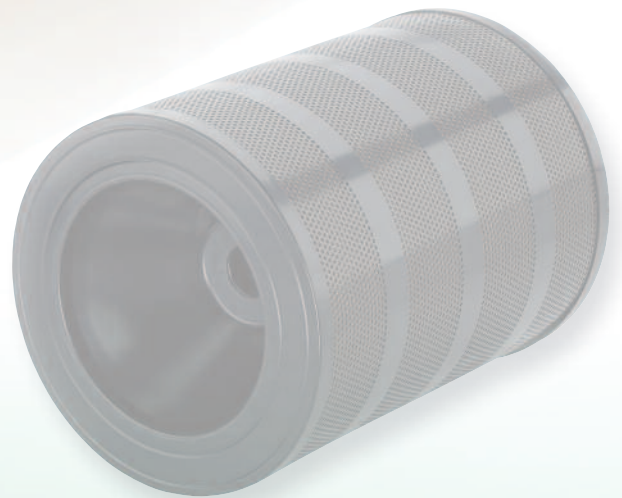

**3 - 5  $\mu\text{m}$**



**14,5 m<sup>2</sup> (156 ft<sup>2</sup>)**



**8,8 kg (19.4 lb.)**



# Fanuc



**H 34 1158/21**

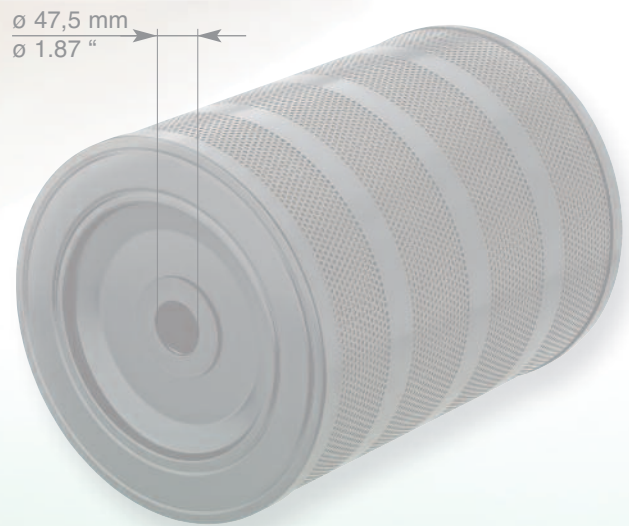

**3 - 5  $\mu\text{m}$**



**14,5 m<sup>2</sup> (156 ft<sup>2</sup>)**



**8,8 kg (19.4 lb.)**

# Fanuc



**H 34 1790/2**

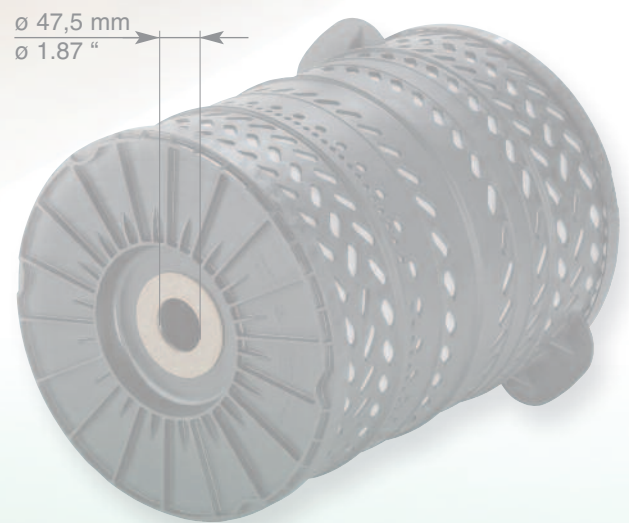

**3 - 5  $\mu\text{m}$**



**17,0 m<sup>2</sup> (183 ft<sup>2</sup>)**



**7,8 kg (17.2 lb.)**





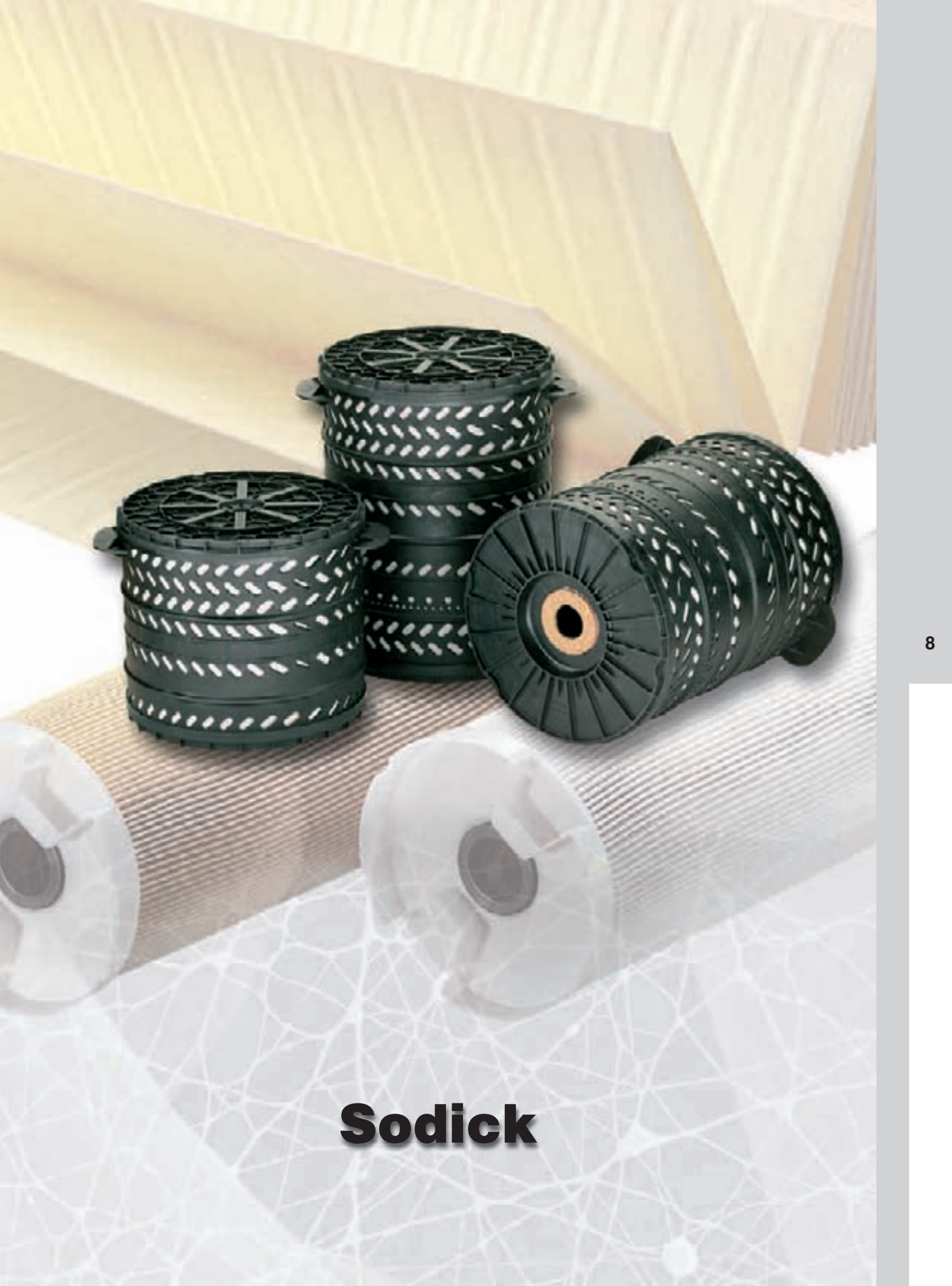

**Sodick**

# Sodick

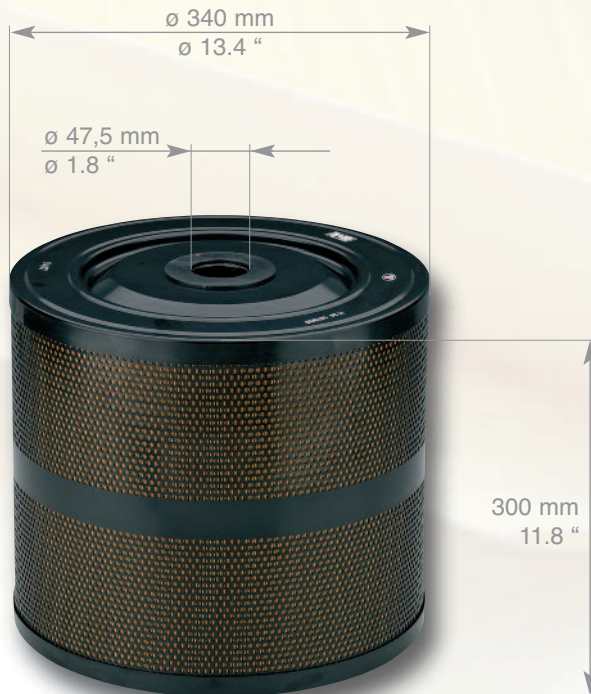

**H 34 1070/1**



**1 - 2  $\mu\text{m}$**



**9,2 m<sup>2</sup> (99 ft<sup>2</sup>)**



**6,5 kg (13.2 lb.)**



# Sodick

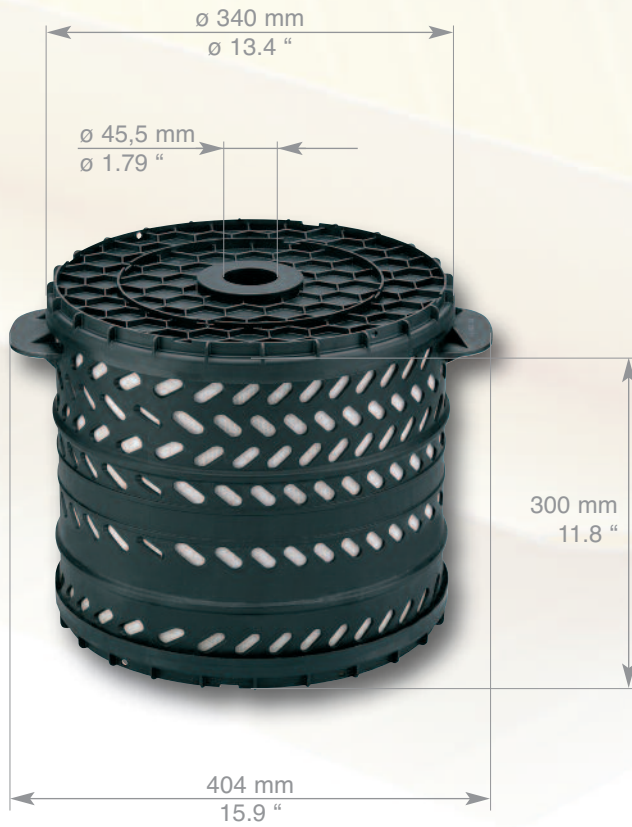

**H 34 1290/3**



WEDM

**3 - 5  $\mu\text{m}$**

**10,5 m<sup>2</sup> (113 ft<sup>2</sup>)**



PL

**6,2 kg (13.7 lb.)**

# Sodick

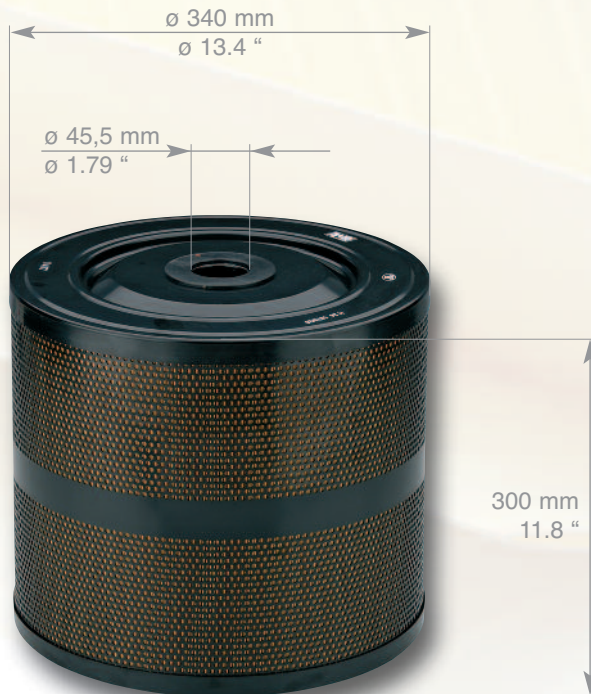

**H 34 1070/20**



WEDM

**3 - 5  $\mu\text{m}$**

**10,7 m<sup>2</sup> (115 ft<sup>2</sup>)**



ST

**6,4 kg (14.1 lb.)**



# Sodick



**H 34 1158/20**

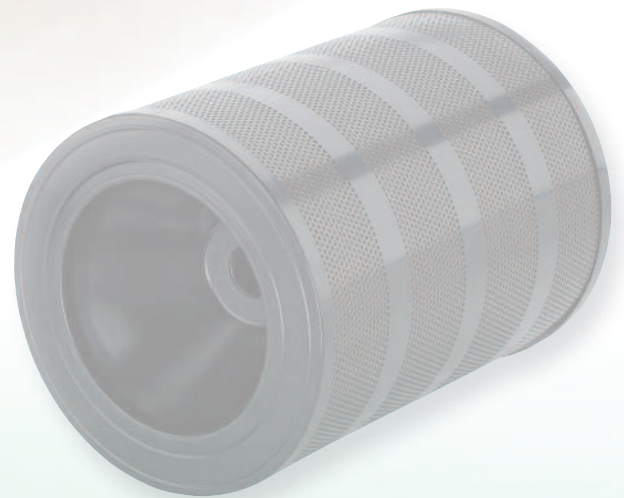

**3 - 5  $\mu\text{m}$**



**14,5 m<sup>2</sup> (156 ft<sup>2</sup>)**



**8,8 kg (19.4 lb.)**

# Sodick

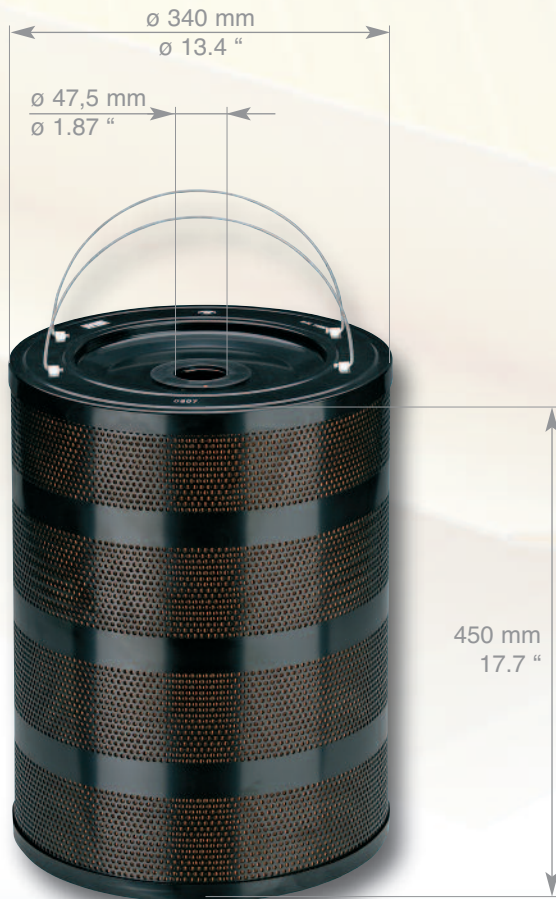

**H 34 1158/22**

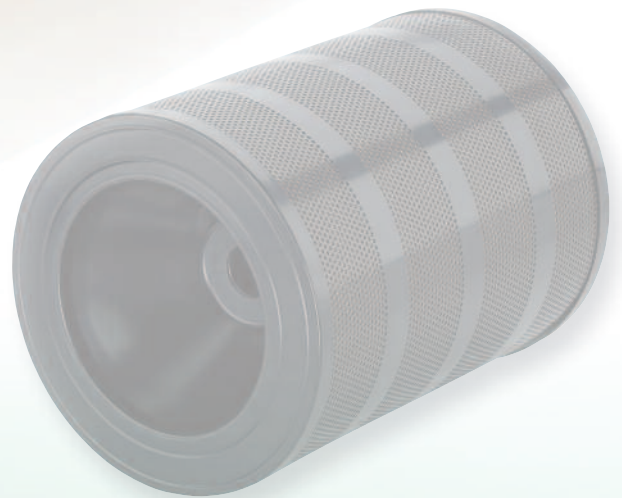

**3 - 5  $\mu\text{m}$**



**14,5 m<sup>2</sup> (156 ft<sup>2</sup>)**



**8,8 kg (19.4 lb.)**



# Sodick



**H 34 1790**

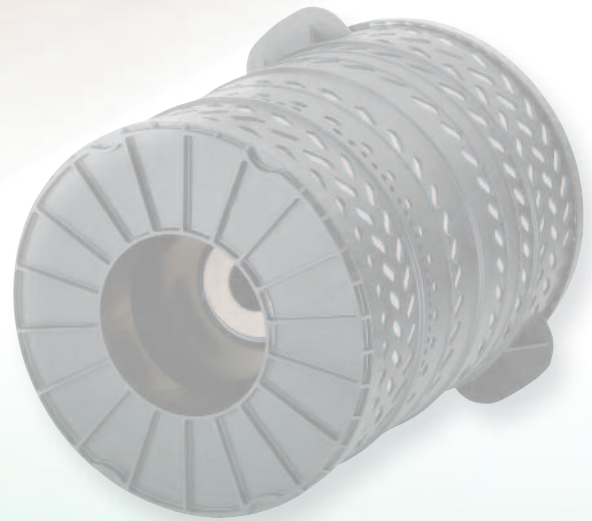

**3 - 5  $\mu\text{m}$**



**17,0 m<sup>2</sup> (183 ft<sup>2</sup>)**



**7,8 kg (17.2 lb.)**



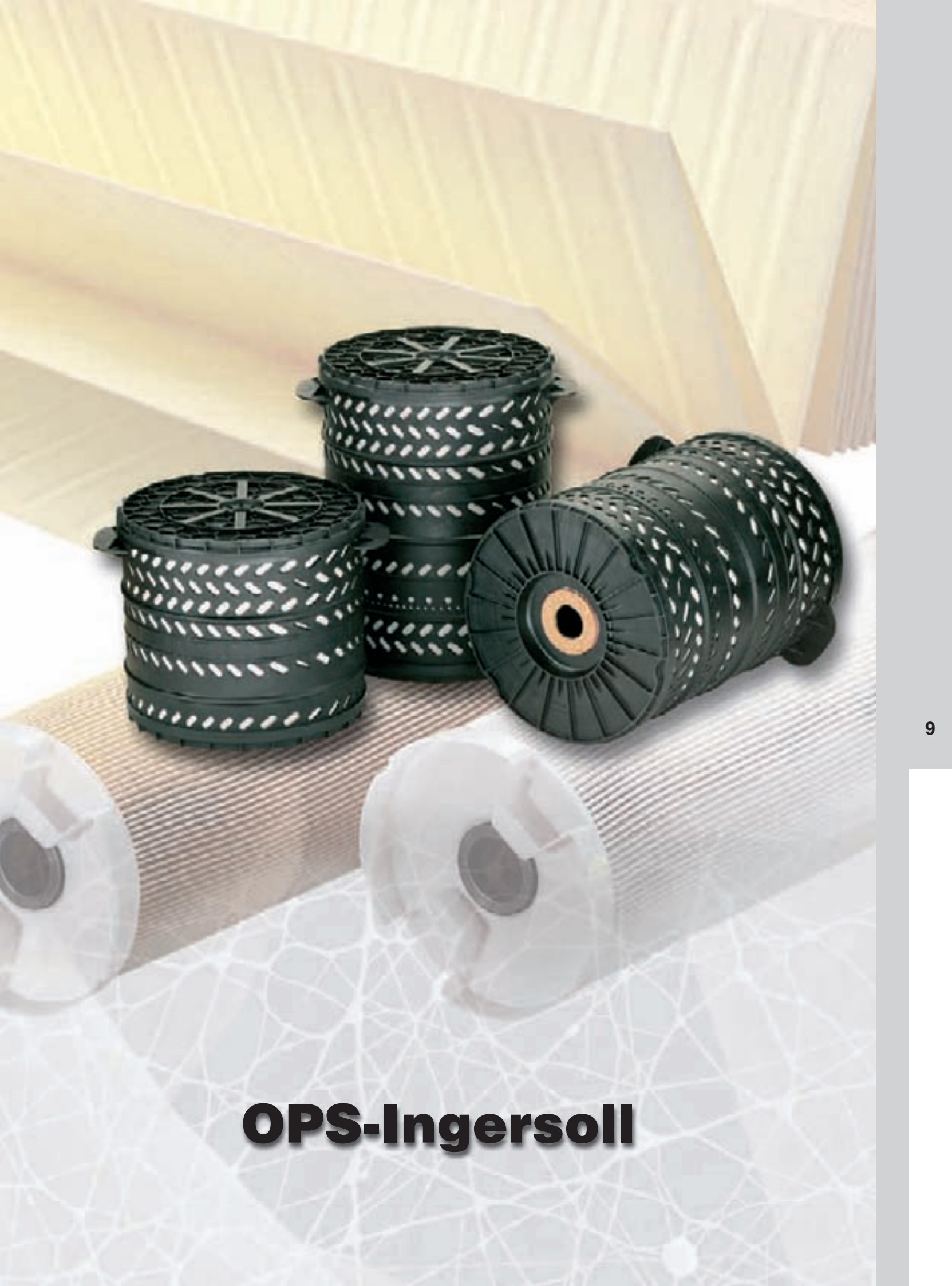

**OPS-Ingersoll**



# OPS-Ingersoll

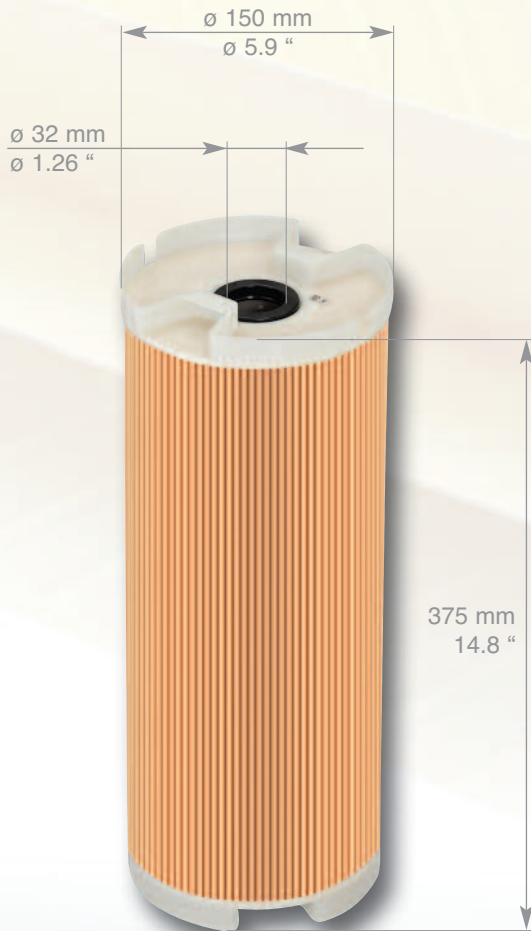

**H 15 190/16**



**3 - 5  $\mu\text{m}$**



**3,1 m<sup>2</sup> (33 ft<sup>2</sup>)**



**0,8 kg (1.8 lb.)**



# OPS-Ingersoll



**H 15 190/6**



**3 - 5 µm**



**2,8 m<sup>2</sup> (30 ft<sup>2</sup>)**



**1,5 kg (3.3 lb.)**



# OPS-Ingersoll

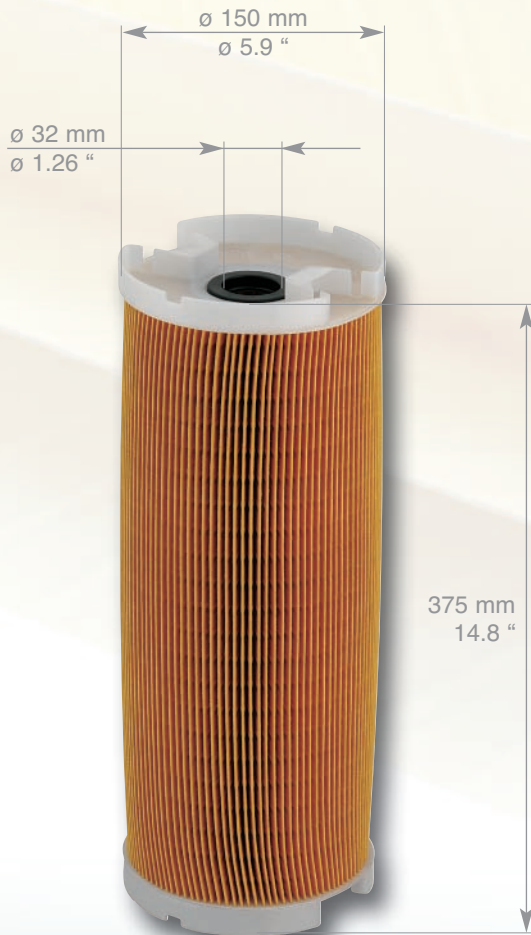

**H 15 190/10**



**10 µm**



**2,8 m<sup>2</sup> (30 ft<sup>2</sup>)**



**0,7 kg (1.5 lb.)**



# OPS-Ingersoll



**H 15 190**



EDM



**10 µm**



ST



**2,1 m<sup>2</sup> (22 ft<sup>2</sup>)**



KG

**1,4 kg (3.1 lb.)**



# OPS-Ingersoll

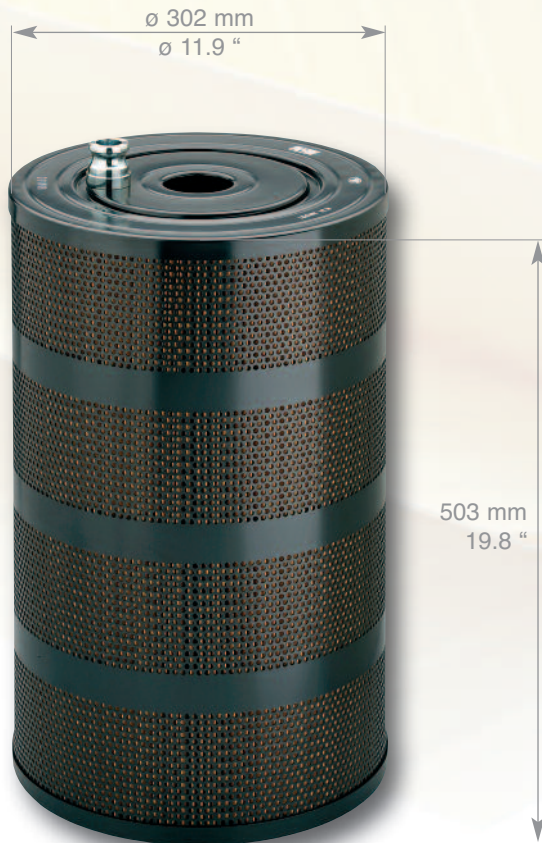

**H 31 1033/21**

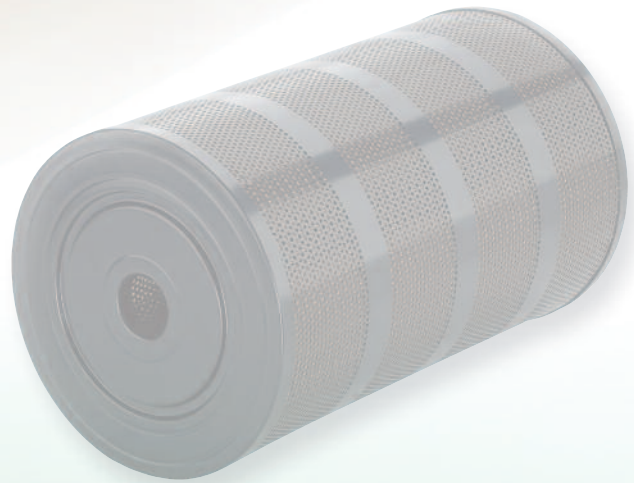

**3 - 5 µm**



**9,9 m<sup>2</sup> (107 ft<sup>2</sup>)**



**6,6 kg (14.6 lb.)**

# OPS-Ingersoll



**H 31 1680**

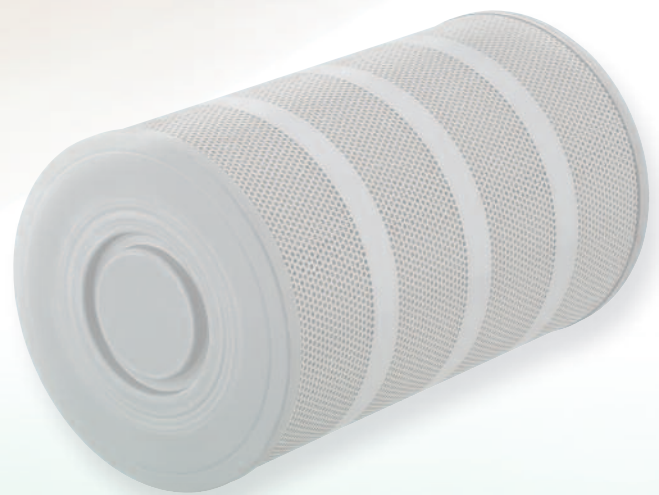

**16,6 m<sup>2</sup> (179 ft<sup>2</sup>)**



**8,8 kg (19.4 lb.)**





# OPS-Ingersoll



**H 31 1680/1**

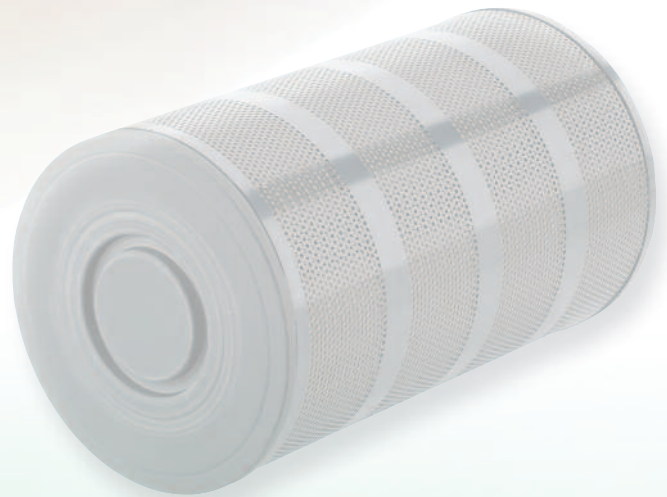

**3 - 5  $\mu\text{m}$**



**16,6 m<sup>2</sup> (179 ft<sup>2</sup>)**



**8,9 kg (19.6 lb.)**





# **Sonstige EDM Filter / Miscellaneous EDM Filters**



**AEG**



**H 15 135 PN**



**3 - 5  $\mu\text{m}$**



**2,1 m<sup>2</sup> (23 ft<sup>2</sup>)**



**1,0 (2.2 lb.)**

**AEG**



**H 15 135 N**



**10  $\mu\text{m}$**



**1,8 m<sup>2</sup> (19 ft<sup>2</sup>)**



**1,0 (2.2 lb.)**



# Agemaspark

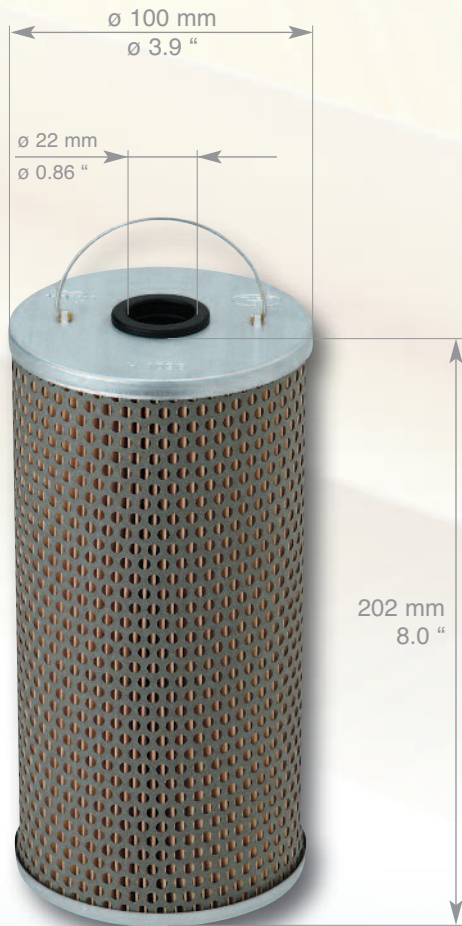

**H 1096**



WEDM

**3 - 5  $\mu\text{m}$**

**0,9 m<sup>2</sup> (10 ft<sup>2</sup>)**



ST

**0,4 (0.8 lb.)**

# Electronica



**H 14 001**



**10 µm**



**3,0 m<sup>2</sup> (32 ft<sup>2</sup>)**



**0,8 kg (1.8 lb.)**



# Electronica



**H 15 290/10**

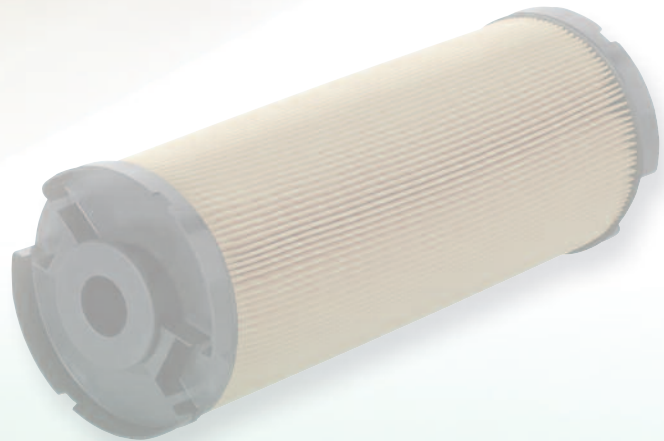

**10 µm**

**2,8 m<sup>2</sup> (30 ft<sup>2</sup>)**



**PL**

**0,7 (1.6 lb.)**

# Electronica



**H 15 290/25**

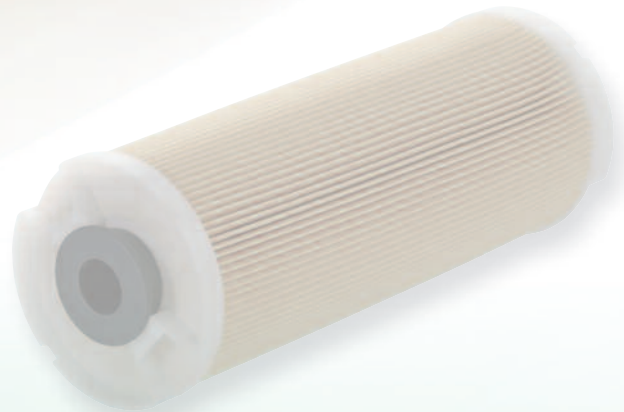

**25  $\mu\text{m}$**



**2,3  $\text{m}^2$  (25  $\text{ft}^2$ )**



**0,8 (1.8 lb.)**



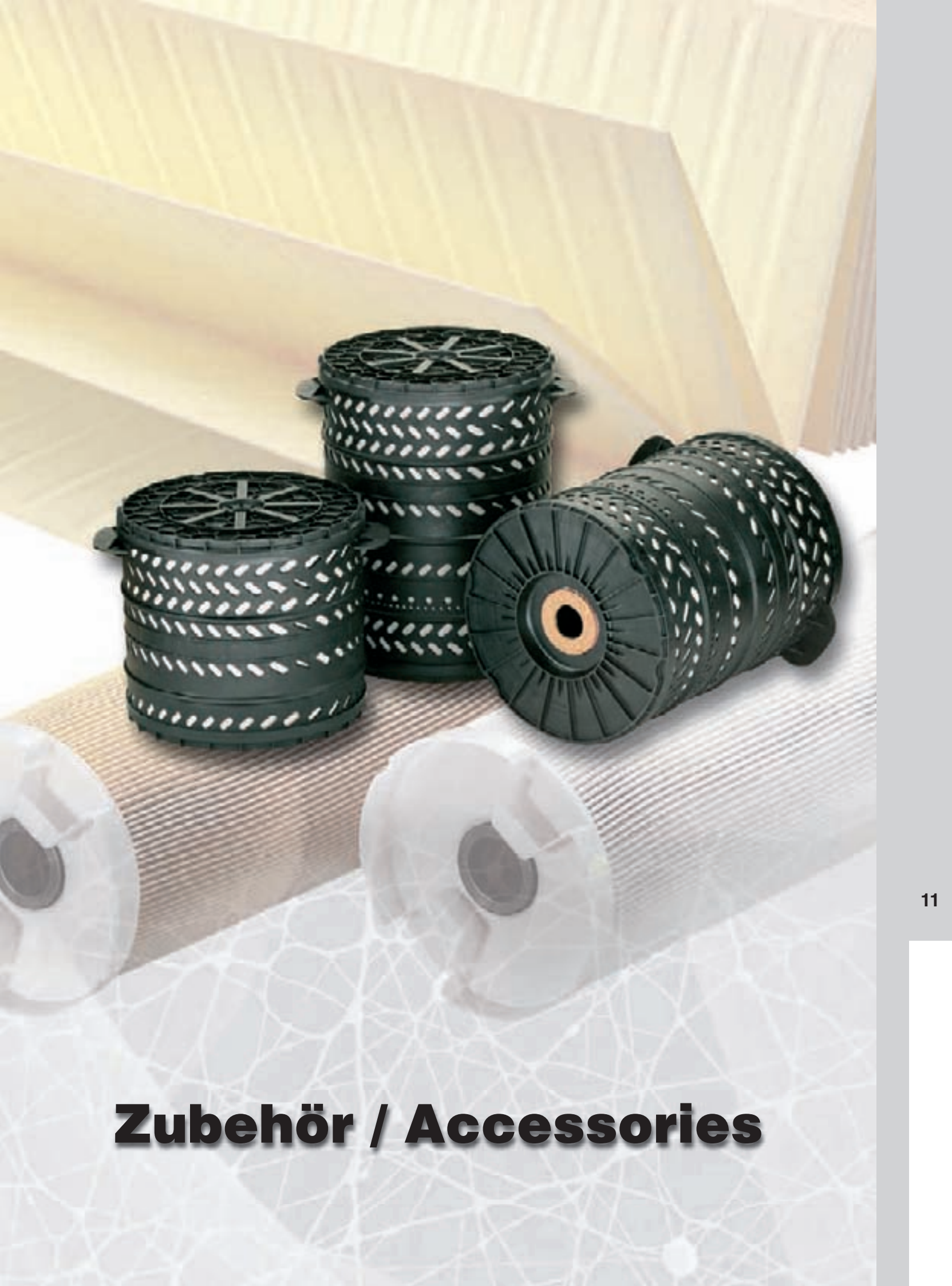

## **Zubehör / Accessories**

## Zubehör / Accessories

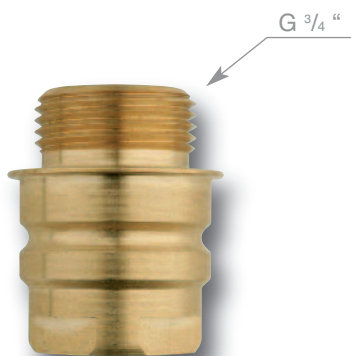

**Fanuc**



**21 027 15 174**



**Fanuc**



**21 027 15 211**

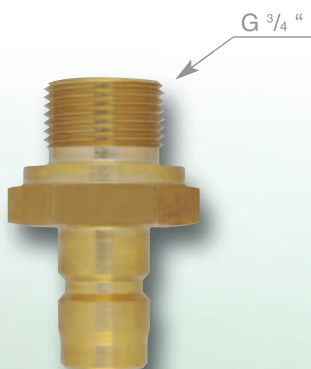

**Mitsubishi Electric,  
Makino, Seibu,  
Joemars, Accutex**



**21 027 15 181**



**Mitsubishi Electric,  
Makino, Seibu,  
Joemars, Accutex**



**21 027 15 212**





## Zubehör / Accessories

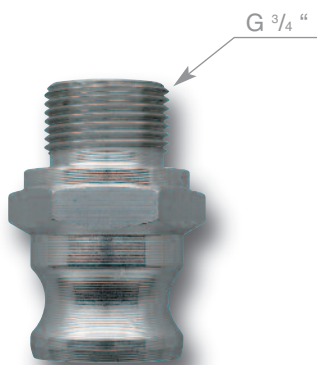

**OPS-Ingersoll**



**21 027 15 171**



**OPS-Ingersoll**



**21 027 15 213**

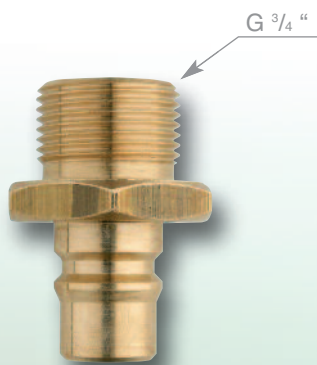

**Hitachi**



**21 027 15 175**



**01 901 20 027**

## Zubehör / Accessories



**67 830 49 001**  
**H 15... PL , E-Line**



**67 092 49 001**  
**H 31... & H 34...**



**Fanuc**



**67 000 50 920**  
**H 34 1790/2,**  
**H 34 1790/3**

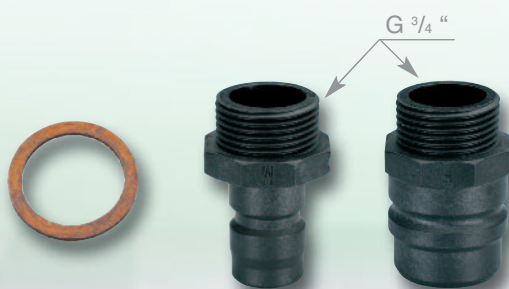

**Fanuc,**  
**Mitsubishi Electric,**  
**Makino, Seibu,**  
**Joemars, Accutex**



**67 000 50 930**



**Fanuc,**  
**Mitsubishi Electric,**  
**Makino, Seibu,**  
**Joemars, Accutex**



**67 000 50 940**



## Zubehör / Accessories



**63 400 62 211**



**PL**



**63 400 51 141**

**KG**

**0,85 kg (1.9 lb.)**



## Zubehör / Accessories



**63 400 62 221**



**PL**



**63 400 51 141**

**KG**

**0,83 kg (1.8 lb.)**





## Zubehör / Accessories



**63 400 62 231**



PL



**63 400 51 141**

KG

**0,83 kg (1.8 lb.)**



## Zubehör / Accessories



**63 400 62 201**



**PL**



**63 400 51 131**

**KG**

**0,58 kg (1.3 lb.)**



## Zubehör / Accessories



**63 400 51 141**



**0,14 kg (0.3 lb.)**



## Zubehör / Accessories



**63 400 51 131**



**0,07 kg (0.2 lb.)**

## Zubehör / Accessories

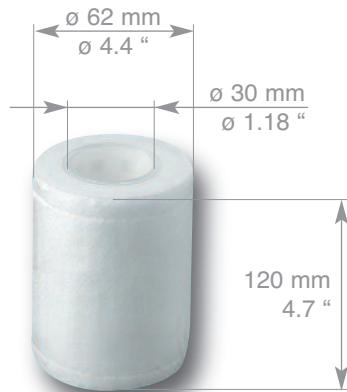

**63 400 51 121**  
**+GF + Agie Charmilles**



**0,07 kg (0.2 lb.)**

















**MANN+HUMMEL GMBH**, Geschäftsbereich Industriefilter  
67346 Speyer, Germany, Telefon +49 (62 32) 53-80, Fax +49 (62 32) 53-88 99  
E-Mail: [edm.info@mann-hummel.com](mailto:edm.info@mann-hummel.com), Internet: [www.mann-hummel.com](http://www.mann-hummel.com)